

A photograph of a room with a window, a chair, and a mirror. The window is white with a view of a blue sky and clouds. The room has light-colored walls and a wooden floor. A brown leather chair is visible in the foreground on the left. A mirror is visible on the right wall.

KATALÓGUS
CATALOGUE

2024/2025

A Hungaria Karnis Kft. több, mint 25 éve van jelen a hazai és nemzetközi függönykarnis piacon, mint az egyik legnagyobb kínálatot felvonultató gyártó és kereskedő. Cégünk 2002 óta 100%-ban magyar tulajdonú.

Termékeink között megtalálhatóak a következő átmérőjű karnisok: 9 mm, 12 mm, 16 mm, 19 mm, 25 mm és 28 mm. Kínálatunkban válogathatnak fém, fa, acél, alumínium és műanyag megoldások között.

A komplett szettek mellett szortimentünk fontos részei a kiegészítők is, mint például a függönyelhúzó pálcák, csipeszek, ráncolókampók vagy függönyelkötő kampók és dekorációs kiegészítők. Forgalmazunk továbbá különböző profilú műanyag és alumínium mennyezeti síneket, illetve rolókat és üvegfóliákat is.

Megtiszteltetés számunkra, hogy kereskedelmi vonalon együttműködő partnereink között tarthatunk számon jelentős európai vállalatokat is Németországban, Horvátországban, Szerbiában, Bosznia Hercegovinában, Szlovéniában, Montenegróban, Romániában és Szlovákiában.

Hungaria Karnis Kft. has been present on the domestic and international curtain rails market for more than 25 years as one of the largest manufacturers and traders offering a wide range of products. Our company is 100% Hungarian owned since 2002.

Our products include the following diameters: 9 mm, 12 mm, 16 mm, 19 mm, 25 mm and 28 mm. We offer metal, wood, steel, aluminium and plastic solutions.

In addition to complete sets, accessories such as curtain rails, clips, curtain hooks or curtain tie hooks and decorative accessories are also an important part of our range. We also sell ceiling rails in various profiles, plastic and aluminium, as well as roller blinds and glass film.

We are also honoured to have major European companies in Germany, Croatia, Serbia, Bosnia and Herzegovina, Slovenia, Montenegro, Romania and Slovakia as our commercial partners.



Milyen karnist válasszak?

A megfelelő karnis kiválasztásánál több tényezőt is érdemes figyelembe venni.

Fontos átgondolni, hogy milyen funkciót szánunk a függönynek.

Amennyiben a cél csak az árnyékolás, abban az esetben elegendő az egysoros változat.

Ha sötétítésre és árnyékolásra is szükség van, akkor a kétsoros karnisokat ajánljuk.

Minél nehezebb, merevebb drapériát választunk, érdemes annál vastagabb átmérőjű karnisban gondolkoznunk.

A karnis hosszát a nyílászáró és a hely szélessége határozza meg. Ez általában az ablakkeret szélességénél 30 cm-el hosszabb karnist jelent, melynek 2 végén helyezkednek el a végzárók.

A tartó kiválasztásánál az elsődleges szempont, hogy az ablak és a mennyezet között mekkora hely áll rendelkezésünkre. Ha ez a hely túl kicsi, abban az esetben mindenképp válasszunk plafontartót.

Which cornice should I choose?

There are several factors to consider when choosing the right cornice.

It is important to consider what function we intend for the curtain.

If the goal is shading only, then a single line version is enough.

If shading is required, we recommend double cornices.

For heavier, stiffer drapes, the thicker cornice is worth thinking about.

The length of the cornice is determined by the width of the doors and windows. This usually means a 30 cm longer cornice with 2 finials from the window frame.

The primary consideration when choosing a bracket is how much space is available between the window and the ceiling.

If this space is too small, be sure to choose a ceiling bracket.

Milyen rolót válasszak?

A szoba fókuszpontja az ablak, ezért az árnyékolónak egyszerre praktikusnak és dekoratívnak is kell lennie.

A roló kiválasztása mindig nehéz dolog, azonban csak néhány alapvető kritériumot kell figyelembe venni ahhoz, hogy megtaláljuk az igazit.

Fontos előre eldönteni, hogy a szobában mennyi fényre van szükségünk.

Ha hálósobába vásárolunk rolót, érdemes a sötétített variációt választani. Ez a típus teljesen kizárja a fényt, így jobban tudunk pihenni, illetve a szoba is „kuckósabbá” válik.

Ha közös helyiségbe, például konyhába keresünk árnyékolót érdemes a fényáteresztő vagy a sávós rolókat választanunk. Azon kívül, hogy engedi megcsillanni a fényt, a kíváncsi tekinteteket sem engedi be otthonunkba.

A méret kiválasztásánál egyszerűen csak az ablak üvegméretét kell lemérnünk. Rolóink mérete a teljes szerkezet nagyságát jelenti, így a vászon méret 4 cm-el kisebb. Ha tehát az ablaküvegünk 76 cm széles, akkor a 80 cm-es rolóra van szükségünk.

Which rollo should I choose?

The focus of the room is the window, so the shade should be both practical and decorative.

Selecting a rollo is always difficult, but there are only a few basic criteria to consider to find the right type.

It is important to decide in advance how much light we need in the room.

When buying blinds for a bedroom, it is worth choosing the Blackout version. This type completely excludes the light, so we can relax and the room becomes more "cozy".

If you are looking for a rollo in a public room, such as a kitchen, you may want to choose Daylight or Duo rollo.

Aside from allowing the light to shine, it does not allow curious glances into our home.

When choosing a size, simply measure the glass size of the window. The size of our blinds is the size of the entire structure, so the screen size is 4 cm smaller. So if your window glass is 76 cm wide, you need a 80 cm blind.



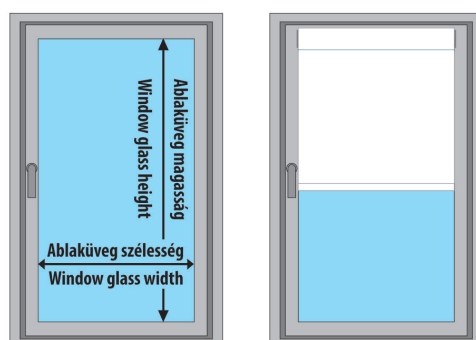
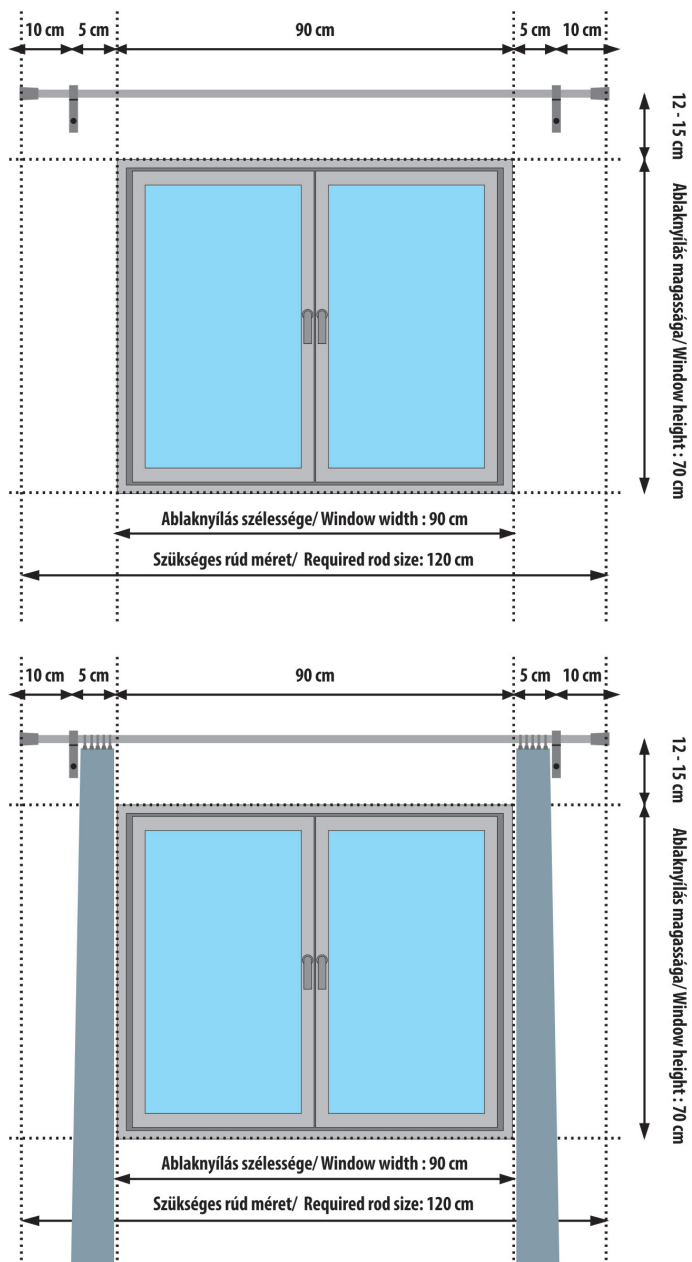

Kávéházi karnisok,
Vitrage pálcák
és tartozékaik

Coffee house,
Vitrage
& accessories



Vitrage pálcák Ø9 mm (fém, műanyag alkatrészekkel)/
Vitrage Ø9 mm (metal with plastic accessories)



| KRÓM/CHROME | | |
|-------------------|------------|----------|
| DIY11.10.14.040-2 | 40-60 cm | 2 db/pcs |
| DIY11.10.14.060-2 | 60-90 cm | 2 db/pcs |
| DIY11.10.14.080-2 | 80-120 cm | 2 db/pcs |
| DIY11.10.14.100-2 | 100-160 cm | 2 db/pcs |

| ANTRACIT/ANTHRACITE | | |
|---------------------|------------|----------|
| DIY11.10.76.040-2 | 40-60 cm | 2 db/pcs |
| DIY11.10.76.060-2 | 60-90 cm | 2 db/pcs |
| DIY11.10.76.080-2 | 80-120 cm | 2 db/pcs |
| DIY11.10.76.100-2 | 100-160 cm | 2 db/pcs |

| REZEZETT/BRASS | | |
|-------------------|------------|----------|
| DIY11.10.13.040-2 | 40-60 cm | 2 db/pcs |
| DIY11.10.13.060-2 | 60-90 cm | 2 db/pcs |
| DIY11.10.13.080-2 | 80-120 cm | 2 db/pcs |
| DIY11.10.13.100-2 | 100-160 cm | 2 db/pcs |

| MATT-KRÓM/CHROME-MATT | | |
|-----------------------|------------|----------|
| DIY11.10.39.040-2 | 40-60 cm | 2 db/pcs |
| DIY11.10.39.060-2 | 60-90 cm | 2 db/pcs |
| DIY11.10.39.080-2 | 80-120 cm | 2 db/pcs |
| DIY11.10.39.100-2 | 100-160 cm | 2 db/pcs |

| FEHÉR/WHITE | | |
|-------------------|------------|----------|
| DIY11.10.01.040-2 | 40-60 cm | 2 db/pcs |
| DIY11.10.01.060-2 | 60-90 cm | 2 db/pcs |
| DIY11.10.01.080-2 | 80-120 cm | 2 db/pcs |
| DIY11.10.01.100-2 | 100-160 cm | 2 db/pcs |

| BARNA/BROWN | | |
|-------------------|------------|----------|
| DIY11.10.04.040-2 | 40-60 cm | 2 db/pcs |
| DIY11.10.04.060-2 | 60-90 cm | 2 db/pcs |
| DIY11.10.04.080-2 | 80-120 cm | 2 db/pcs |
| DIY11.10.04.100-2 | 100-160 cm | 2 db/pcs |



| ÖNTAPADÓS VITRAGE KAMPÓ/ SELF-ADHESIVE HOOK | | |
|--|----------|--|
| DIY119050.01-4 | 4 db/pcs | |
| DIY119050.04-4 | 4 db/pcs | |
| DIY119050.13-4 | 4 db/pcs | |
| DIY119050.39-4 | 4 db/pcs | |
| DIY119050.14-4 | 4 db/pcs | |
| DIY119050.76-4 | 4 db/pcs | |

FLEX Önfeszítő rúd Ø9 mm (fém, műanyag alkatrészekkel)
FLEX Tension Rod Ø9 mm (metal with plastic accessories)



ÖNFESZÍTŐ ÉK

DIY098121.01-4 4db/pcs

FEHÉR/WHITE

| | | |
|-------------------|------------|----------|
| DIY09.10.01.040-2 | 40-70 cm | 2 db/pcs |
| DIY09.10.01.060-2 | 60-80 cm | 2 db/pcs |
| DIY09.10.01.080-2 | 80-110 cm | 2 db/pcs |
| DIY09.10.01.100-2 | 100-140 cm | 2 db/pcs |

MATT-KRÓM/CHROME-MATT

| | | |
|-------------------|------------|----------|
| DIY09.10.39.040-2 | 40-70 cm | 2 db/pcs |
| DIY09.10.39.060-2 | 60-80 cm | 2 db/pcs |
| DIY09.10.39.080-2 | 80-110 cm | 2 db/pcs |
| DIY09.10.39.100-2 | 100-140 cm | 2 db/pcs |

Jetran önfeszítő rúd Ø25/22 mm (fém, műanyag alkatrészekkel)
Jetran Tension Rod Ø25/22 mm (metal with plastic accessories)



FEHÉR/WHITE

| | | |
|-------------------|--------------|----------|
| DIY23.10.01.065.b | 65 - 100 cm | 1 db/pcs |
| DIY23.10.01.080.b | 80 - 130 cm | 1 db/pcs |
| DIY23.10.01.130.b | 130 - 220 cm | 1 db/pcs |

KRÓM/CHROME

| | | |
|-------------------|--------------|----------|
| DIY23.10.14.065.b | 65 - 100 cm | 1 db/pcs |
| DIY23.10.14.080.b | 80 - 130 cm | 1 db/pcs |
| DIY23.10.14.130.b | 130 - 220 cm | 1 db/pcs |

Zuhanyfüggöny karika
Shower curtain ring



**ZUHANYFÜGGÖNY KARIKA/
SHOWER CURTAIN RING**

| | | | |
|-----------------|------------------|----------------------|--|
| DIY501035.15-10 | 35 mm | átlátszó/transparent | |
| DIY501035.01-10 | 35 mm | fehér/white | |
| DIY501000.15-10 | C alakú/C shaped | átlátszó/transparent | |
| DIY501000.01-10 | C alakú/C shaped | fehér/white | |

Vitrage TWIST Ø9 mm (állítható/adjustable)



NEW

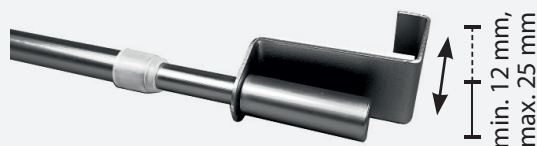
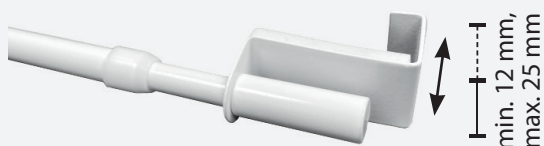

| FEHÉR/WHITE | | |
|-------------------|-------------|----------|
| DIY09.20.01.040-1 | 40 - 60 cm | 1 db/pcs |
| DIY09.20.01.060-1 | 60 - 90 cm | 1 db/pcs |
| DIY09.20.01.090-1 | 90 - 130 cm | 1 db/pcs |

| NEMESFÉM/INOX | | |
|-------------------|-------------|----------|
| DIY09.20.77.040-1 | 40 - 60 cm | 1 db/pcs |
| DIY09.20.77.060-1 | 60 - 90 cm | 1 db/pcs |
| DIY09.20.77.090-1 | 90 - 130 cm | 1 db/pcs |

Kávéházi karnis Ø12 mm (fém, műanyag alkatrészekkel)
Coffee house Ø12 mm (metal with plastic accessories)



| FEHÉR/WHITE | | |
|-----------------|------------|----------|
| DIY12.40.01.055 | 050-085 cm | 1 db/pcs |
| DIY12.40.01.085 | 075-135 cm | 1 db/pcs |
| DIY12.40.01.135 | 120-225 cm | 1 db/pcs |

| REZEZETT/BRASS | | |
|-----------------|------------|----------|
| DIY12.40.13.055 | 050-085 cm | 1 db/pcs |
| DIY12.40.13.085 | 075-135 cm | 1 db/pcs |
| DIY12.40.13.135 | 120-225 cm | 1 db/pcs |

| MATT-KRÓM/CHROME-MATT | | |
|-----------------------|------------|----------|
| DIY12.40.39.055 | 050-085 cm | 1 db/pcs |
| DIY12.40.39.085 | 075-135 cm | 1 db/pcs |
| DIY12.40.39.135 | 120-225 cm | 1 db/pcs |

| KRÓM/CHROME | | |
|-----------------|------------|----------|
| DIY12.40.14.055 | 050-085 cm | 1 db/pcs |
| DIY12.40.14.085 | 075-135 cm | 1 db/pcs |
| DIY12.40.14.135 | 120-225 cm | 1 db/pcs |

| FEKETE/BLACK | | |
|-----------------|------------|----------|
| DIY12.40.21.055 | 050-085 cm | 1 db/pcs |
| DIY12.40.21.085 | 075-135 cm | 1 db/pcs |
| DIY12.40.21.135 | 120-225 cm | 1 db/pcs |



| KÁVÉHÁZI TARTOZÉKCSOMAG | | |
|-------------------------|----------|--|
| SB 128304.01-4 | 4 db/pcs | |
| SB 128304.13-4 | 4 db/pcs | |
| SB 128304.21-4 | 4 db/pcs | |
| SB 128304.39-4 | 4 db/pcs | |

Univerzális tartozékcsoomag



| UNIVERZÁLIS ÁTLÁTSZÓ TARTOZÉKCSOMAG | |
|-------------------------------------|----------|
| DIY129050.15-4 | 4 db/pcs |

Kihúzható
fémkarnisok
és tartozékaik

Extendible
metal curtain rods
& accessories

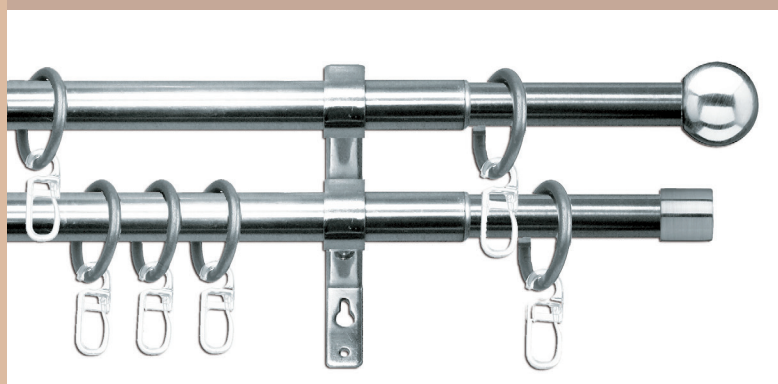

Ø19/16 mm - 2 in 1 - kihúzható karika nélkül
Ø19/16 mm - 2 in 1 - extendible without rings

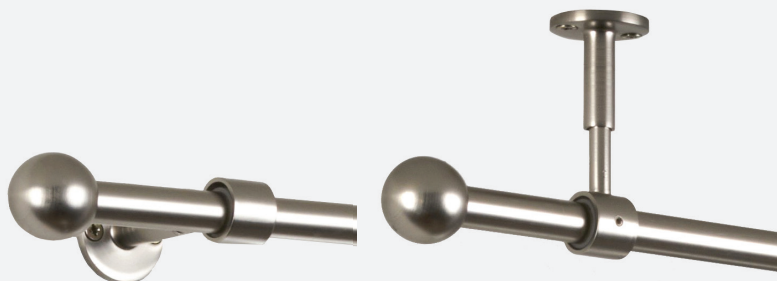

NEW

**2 IN 1 KIHÚZHATÓ KARIKA NÉLKÜL/
2 IN 1 EXTENDIBLE WITHOUT RINGS**

| | | | | |
|---------------------|--------------|----------|--------------|--|
| DIY1916.05.77.120.b | 120 - 210 cm | 1 db/pcs | Inox | |
| DIY1916.05.77.200.b | 160 - 280 cm | 1 db/pcs | Inox | |
| DIY1916.05.21.120.b | 120 - 210 cm | 1 db/pcs | fekete/black | |
| DIY1916.05.21.200.b | 160 - 280 cm | 1 db/pcs | fekete/black | |

Ø16/13 mm - kihúzható karika nélkül
Ø16/13 mm - extendible without rings



**KIHÚZHATÓ 1 SOROS KARIKA NÉLKÜL/
EXTENDIBLE 1 TRACK WITHOUT RINGS**

| | | | |
|-------------------|------------|------|--|
| DIY1613.01.77.120 | 120-210 cm | Inox | |
| DIY1613.01.77.165 | 165-300 cm | Inox | |



**KIHÚZHATÓ 1 SOROS KARIKA NÉLKÜL/
EXTENDIBLE 1 TRACK WITHOUT RINGS**

| | | | |
|-------------------|------------|--------------|--|
| DIY1613.05.21.120 | 120-210 cm | fekete/black | |
| DIY1613.05.21.165 | 165-300 cm | fekete/black | |



**KIHÚZHATÓ 1 SOROS KARIKA NÉLKÜL/
EXTENDIBLE 1 TRACK WITHOUT RINGS**

| | | | |
|-------------------|------------|--------------|--|
| DIY1613.03.01.165 | 165-300 cm | fehér/white | |
| DIY1613.03.21.120 | 120-210 cm | fekete/black | |
| DIY1613.03.21.165 | 165-300 cm | fekete/black | |



**KARIKA RÁNCSEDŐVEL/
RING WITH HOOK**

| | | | |
|-----------------|-----------|-------------------------|--|
| DIY208081.40-10 | 10 db/pcs | nikkel-matt/nickel matt | |
| DIY208084.21-10 | 10 db/pcs | fekete/black | |
| DIY259091.77-10 | 10 db/pcs | Inox | |

Ø19/16 mm kihúzható 1 soros nemesfém karnis
Ø19/16 mm extendible 1 track with inox rings & hooks

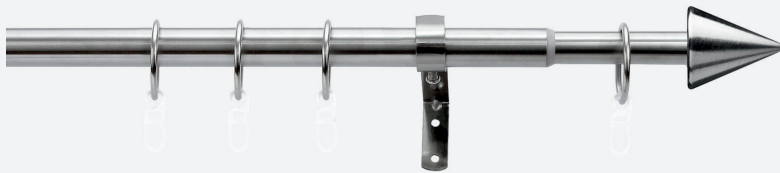

**KIHÚZHATÓ 1 SOROS NEMESFÉM KARNIS/
EXTENDIBLE 1 TRACK WITH RINGS & HOOKS**

| | | |
|---------------------|------------|-----------|
| DIY1916.02.77.120.b | 120-230 cm | Inox/Inox |
| DIY1916.02.77.200.b | 200-350 cm | Inox/Inox |

Ø19/16 mm kihúzható 1 soros karnis
Ø19/16 mm extendible 1 track with rings & hooks

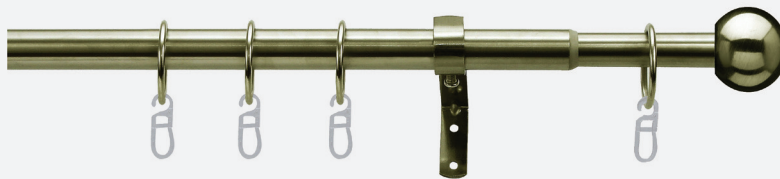

**KIHÚZHATÓ 1 SOROS KARNIS/
EXTENDIBLE 1 TRACK WITH RINGS & HOOKS**

| | | |
|---------------------|------------|---------------------|
| DIY1916.12.77.120.b | 120-230 cm | Inox/Inox |
| DIY1916.12.77.200.b | 200-350 cm | Inox/Inox |
| DIY1916.12.62.120.b | 120-230 cm | óarany/antique gold |
| DIY1916.12.62.200.b | 200-350 cm | óarany/antique gold |

Ø19/16 mm kihúzható 2 soros karnis
Ø19/16 mm extendible 2 track with rings & hooks

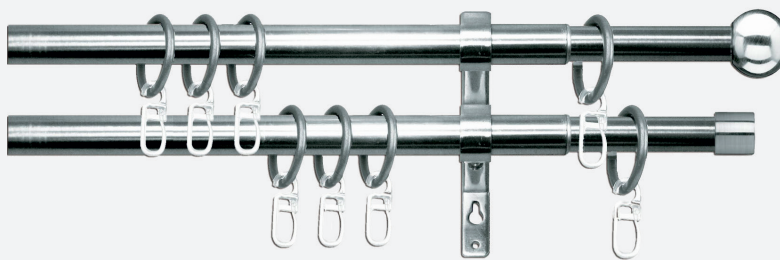

**KIHÚZHATÓ 2 SOROS KARNIS/
EXTENDIBLE 2 TRACK WITH RINGS & HOOKS**

| | | |
|-----------------------|------------|---------------------|
| DIY1916.12.77.120-2.b | 120-230 cm | Inox/Inox |
| DIY1916.12.77.200-2.b | 200-350 cm | Inox/Inox |
| DIY1916.12.62.120-2.b | 120-230 cm | óarany/antique gold |
| DIY1916.12.62.200-2.b | 200-350 cm | óarany/antique gold |



**KARIKA RÁNCSEDŐVEL/
RING WITH HOOK**

| | | |
|-----------------|-----------|---------------------|
| DIY259091.77-10 | 10 db/pcs | Inox |
| DIY208084.62-10 | 10 db/pcs | óarany/antique gold |

Akciós karnisok Discount curtain rods

Ø16/13 mm karnis szett Lilie 1-soros
Ø16/13 mm curtain rod set Lilie 1 line



| FEKETE-MATT/BLACK-MATT | |
|------------------------|------------|
| AKC1613.20.21.070 | 70-120 cm |
| AKC1613.20.21.130 | 130-240 cm |



| NIKKEL-MATT/NICKELL-MATT | |
|--------------------------|------------|
| AKC1613.20.40.070 | 70-120 cm |
| AKC1613.20.40.130 | 130-240 cm |

Ø16/13 mm karnis szett Kúp 1-soros
Ø16/13 mm curtain rod set Kúp 1 line



| FEKETE-MATT/BLACK-MATT | |
|------------------------|------------|
| AKC1613.22.21.070 | 70-120 cm |
| AKC1613.22.21.130 | 130-240 cm |



| NIKKEL-MATT/NICKELL-MATT | |
|--------------------------|------------|
| AKC1613.40.21.070 | 70-120 cm |
| AKC1613.40.21.130 | 130-240 cm |

Ø16 mm -es fémkarnisok Ø16 mm metal set



Pannónia 1 soros fémkarnis Ø16 mm - végzáró nélkül
Pannonia 1 track Ø16 metal set - without finials



| FEKETE-MATT/BLACK-MATT | |
|------------------------|--------|
| DIY16.05.21.120 | 120 cm |
| DIY16.05.21.160 | 160 cm |
| DIY16.05.21.200 | 200 cm |
| DIY16.05.21.240 | 240 cm |
| DIY16.05.21.300 | 300 cm |

| NIKKEL-MATT/NICKELL-MATT | |
|--------------------------|--------|
| DIY16.05.40.120 | 120 cm |
| DIY16.05.40.160 | 160 cm |
| DIY16.05.40.200 | 200 cm |
| DIY16.05.40.240 | 240 cm |
| DIY16.05.40.300 | 300 cm |

| ÓARANY/ANTIQUÉ GOLD | |
|---------------------|--------|
| DIY16.05.62.120 | 120 cm |
| DIY16.05.62.160 | 160 cm |
| DIY16.05.62.200 | 200 cm |
| DIY16.05.62.240 | 240 cm |
| DIY16.05.62.300 | 300 cm |

Pannónia 2 soros fémkarnis - Ø16 mm - végzáró nélkül
Pannonia 2 track Ø16 mm metal set - without finials



| FEKETE-MATT/BLACK-MATT | |
|------------------------|--------|
| DIY16.55.21.120 | 120 cm |
| DIY16.55.21.160 | 160 cm |
| DIY16.55.21.200 | 200 cm |
| DIY16.55.21.240 | 240 cm |
| DIY16.55.21.300 | 300 cm |

| NIKKEL-MATT/NICKELL-MATT | |
|--------------------------|--------|
| DIY16.55.40.120 | 120 cm |
| DIY16.55.40.160 | 160 cm |
| DIY16.55.40.200 | 200 cm |
| DIY16.55.40.240 | 240 cm |
| DIY16.55.40.300 | 300 cm |

| ÓARANY/ANTIQUÉ GOLD | |
|---------------------|--------|
| DIY16.55.62.120 | 120 cm |
| DIY16.55.62.160 | 160 cm |
| DIY16.55.62.200 | 200 cm |
| DIY16.55.62.240 | 240 cm |
| DIY16.55.62.300 | 300 cm |

A komplett kiserelés tartalmazza a tartókat (240 cm felett 3 tartó), karikákat ráncszedő kampókkal, valamint a felszereléshez szükséges csavarokat és tipliket.

Including 2 brackets (from 240 cm 3rd bracket) rings and hooks, fixing material (screws and dowels).

Amerika 1 soros Ø16 mm fémkarnis- végzáró nélkül
America 1 track Ø16 mm metal set - without finials

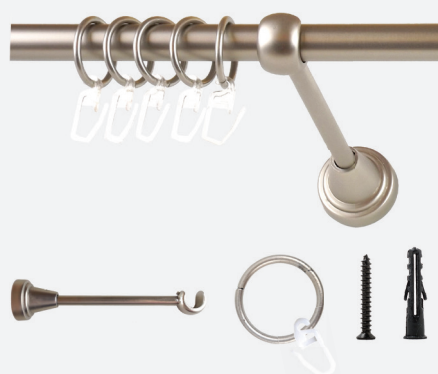

| NIKKEL-MATT/NICKELL-MATT | |
|--------------------------|--------|
| DIY16.06.40.120 | 120 cm |
| DIY16.06.40.160 | 160 cm |
| DIY16.06.40.200 | 200 cm |
| DIY16.06.40.240 | 240 cm |
| DIY16.06.40.300 | 300 cm |

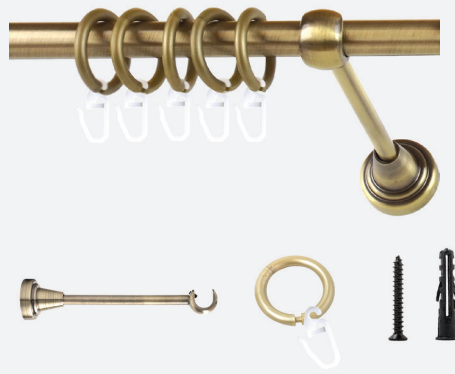

| ÓRANY/ANTIQUÉ GOLD | |
|--------------------|--------|
| DIY16.06.62.120 | 120 cm |
| DIY16.06.62.160 | 160 cm |
| DIY16.06.62.200 | 200 cm |
| DIY16.06.62.240 | 240 cm |
| DIY16.06.62.300 | 300 cm |

Amerika 2 soros Ø16 mm fémkarnis - végzáró nélkül
America 2 track Ø16 mm metal set - without finials



| NIKKEL-MATT/NICKELL-MATT | |
|--------------------------|--------|
| DIY16.66.40.120 | 120 cm |
| DIY16.66.40.160 | 160 cm |
| DIY16.66.40.200 | 200 cm |
| DIY16.66.40.240 | 240 cm |
| DIY16.66.40.300 | 300 cm |



| ÓRANY/ANTIQUÉ GOLD | |
|--------------------|--------|
| DIY16.66.62.120 | 120 cm |
| DIY16.66.62.160 | 160 cm |
| DIY16.66.62.200 | 200 cm |
| DIY16.66.62.240 | 240 cm |
| DIY16.66.62.300 | 300 cm |

A komplett kiserelés tartalmazza a tartókat (240 cm felett 3 tartó), karikákat ráncszedő kampókkal, valamint a felszereléshez szükséges csavarokat és tipliket.
Including 2 brackets (from 240 cm 3rd bracket) rings and hooks, fixing material (screws and dowels).



5,5 cm

MOHÁCS

DIY168020.21-2 16 mm 2 db/pcs



11,7 cm

SOPRON

DIY168012.21-2 16 mm 2 db/pcs



10,5 cm

SZELLŐ

DIY168021.21-2 16 mm 2 db/pcs



13 cm

TATA

DIY168015.21-2 16 mm 2 db/pcs

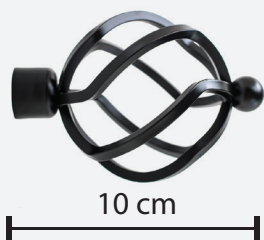

10 cm

SZEGED

DIY168016.21-2 16 mm 2 db/pcs

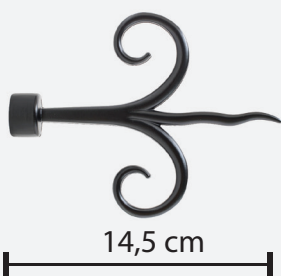

14,5 cm

KECSKEMÉT

DIY168018.21-2 16 mm 2 db/pcs



2,5 cm

VESZPRÉM

DIY168019.21-2 16 mm 2 db/pcs



2 cm

VILLÁNY

DIY167027.21-2 16 mm 2 db/pcs

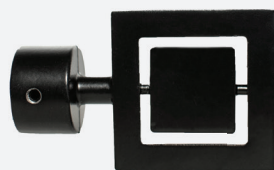

6,5 cm

CHICAGO

DIY167023.21-2 16 mm 2 db/pcs



13 cm

KESZTHELY

DIY168011.21-2 16 mm 2 db/pcs



12 cm

SIÓFOK

DIY168010.21-2 16 mm 2 db/pcs

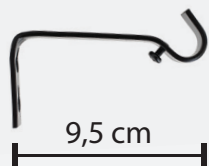

9,5 cm

**SZIMPLA LAPOS TARTÓ/
SINGLE BRACKET**

DIY168112.21-1 16 mm 1 db/pcs

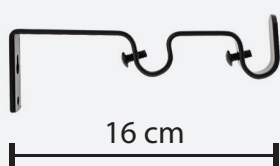

16 cm

**DUPLA LAPOS TARTÓ/
DOUBLE BRACKET**

DIY168113.21-1 16 mm 1 db/pcs



2 cm

**OLDALFALI TARTÓ/
ROD SOCKET**

DIY168121.21-2 16 mm 2 db/pcs



18 mm

**SAROKTOLDÓ/
ADJUSTABLE CONNECTOR**

DIY168199.21-1 1 db/pcs



KNICKI-KAMPÓ/KNICKI-HOOK

DIY101000.15-10 átlátszó 10 db/pcs



**KARIKA RÁNCSEDŐVEL/
RING WITH HOOK**

DIY208081.21-10 műanyag 10 db/pcs



**FÉM KARIKA CSIPESSZEL/
METAL RING WITH CLIPS**

DIY208083.21-10 10 db/pcs

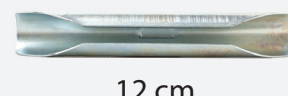

12 cm

CSŐTOLDÓ/CONNECTOR

DIY168017-1 16 mm 1 db/pcs



5,5 cm

MOHÁCS

DIY168020.40-2 16 mm 2 db/pcs



11,7 cm

SOPRON

DIY168012.40-2 16 mm 2 db/pcs



10,5 cm

SZELLŐ

DIY168021.40-2 16 mm 2 db/pcs



13 cm

TATA

DIY168015.40-2 16 mm 2 db/pcs



10 cm

SZEGED

DIY168016.40-2 16 mm 2 db/pcs



14,5 cm

KECSKEMÉT

DIY168018.40-2 16 mm 2 db/pcs



2,5 cm

VESZPRÉM

DIY168019.40-2 16 mm 2 db/pcs

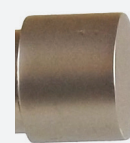

2 cm

VILLÁNY

DIY167027.40-2 16 mm 2 db/pcs



5,5 cm

ST. LOUIS

DIY167034.40-2 16 mm 2 db/pcs



4,5 cm

LOS ANGELES

DIY167028.40-2 16 mm 2 db/pcs



4,2 cm

BOSTON

DIY167022.40-2 16 mm 2 db/pcs



5 cm

LAS VEGAS

DIY167038.40-2 16 mm 2 db/pcs

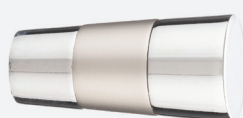

10 cm

TOLEDO

DIY167039.40-2 16 mm 2 db/pcs

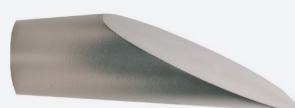

6,8 cm

DETROIT

DIY167025.40-2 16 mm 2 db/pcs



5 cm

BALTIMORE

DIY167009.40-2 16 mm 2 db/pcs



6,5 cm

PORTLAND

DIY167010.40-2 16 mm 2 db/pcs



11 cm

SEATTLE

DIY167011.40-2 16 mm 2 db/pcs



13,5 cm

ATLANTA

DIY167012.40-2 16 mm 2 db/pcs



13 cm

LEXINGTON

DIY167014.40-2 16 mm 2 db/pcs

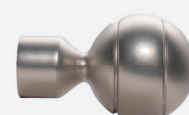

5,5 cm

NEW ORLEANS

DIY167031.40-2 16 mm 2 db/pcs



18,5 cm

**SZIMPLA PLAFONTARTÓ/
SINGLE CEILING BRACKET**

DIY168117.40-1 16 mm 1 db/pcs

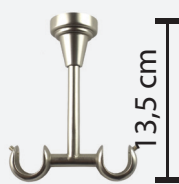

13,5 cm

**DUPLA PLAFONTARTÓ/
DOUBLE CEILING BRACKET**

DIY168118.40-1 16 mm 1 db/pcs

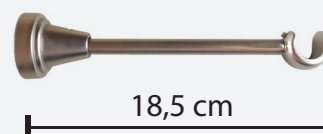

18,5 cm

**SZIMPLA TARTÓ/
SINGLE BRACKET**

DIY168114.40-1 16 mm 1 db/pcs



18,5 cm

**DUPLA TARTÓ/
DOUBLE BRACKET**

DIY168115.40-1 16 mm 1 db/pcs

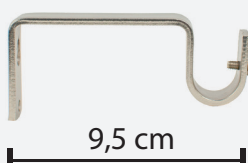

9,5 cm

**SZIMPLA LAPOS TARTÓ/
SINGLE FLAT BRACKET**

DIY168112.40-1 16 mm 1 db/pcs



16 cm

**DUPLA LAPOS TARTÓ/
DOUBLE FLAT BRACKET**

DIY168113.40-1 16 mm 1 db/pcs



**KARIKA RÁNCSEDŐVEL/
RING WITH HOOK**

DIY208081.40-10 nikkel-matt 10 db/pcs



**FÉM KARIKA CSIPESSZEL/
METAL RING WITH CLIPS**

DIY208083.40-10 10 db/pcs



18 mm

**SAROKTOLDÓ/
ADJUSTABLE CONNECTOR**

DIY168199.40-1 16 mm 1 db/pcs



KNICKI-KAMPÓ/KNICKI-HOOK

DIY101000.15-10 átlátszó 10 db/pcs



2 cm

**OLDALFALI TARTÓ/
ROD SOCKET**

DIY168121.40-2 16 mm 2 db/pcs



12 cm

CSŐTOLDÓ/CONNECTOR

DIY168017-1 16 mm 1 db/pcs



5,5 cm

MOHÁCS

DIY168020.62-2 16 mm 2 db/pcs



5,5 cm

ST. LOUIS

DIY167034.62-2 16 mm 2 db/pcs

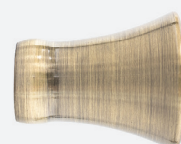

4,5 cm

LOS ANGELES

DIY167028.62-2 16 mm 2 db/pcs



4,2 cm

BOSTON

DIY167022.62-2 16 mm 2 db/pcs



13 cm

TATA

DIY168015.62-2 16 mm 2 db/pcs



10 cm

SZEGED

DIY168016.62-2 16 mm 2 db/pcs

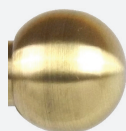

2,5 cm

VESZPRÉM

DIY168019.62-2 16 mm 2 db/pcs

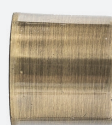

2 cm

VILLÁNY

DIY167027.62-2 16 mm 2 db/pcs



6,8 cm

DETROIT

DIY167025.62-2 16 mm 2 db/pcs



5 cm

BALTIMORE

DIY167009.62-2 16 mm 2 db/pcs



6,5 cm

PORTLAND

DIY167010.62-2 16 mm 2 db/pcs



11 cm

SEATTLE

DIY167011.62-2 16 mm 2 db/pcs



13,5 cm

ATLANTA

DIY167012.62-2 16 mm 2 db/pcs



13 cm

LEXINGTON

DIY167014.62-2 16 mm 2 db/pcs



5,5 cm

NEW ORLEANS

DIY167031.62-2 16 mm 2 db/pcs



10,5 cm

| | | |
|----------------|-------|----------|
| SZELLŐ | | |
| DIY168021.62-2 | 16 mm | 2 db/pcs |



5 cm

| | | |
|------------------|-------|----------|
| LAS VEGAS | | |
| DIY167038.62-2 | 16 mm | 2 db/pcs |



18 mm

| | | |
|---|-------|----------|
| SAROKTOLDÓ/ ADJUSTABLE CONNECTOR | | |
| DIY168199.62-1 | 16 mm | 1 db/pcs |



13,5 cm

| | | |
|--|-------|----------|
| DUPLA PLAFONTARTÓ/ DOUBLE CEILING BRACKET | | |
| DIY168118.62-1 | 16 mm | 1 db/pcs |



18,5 cm

| | | |
|--|-------|----------|
| SZIMPLA PLAFONTARTÓ/ SINGLE CEILING BRACKET | | |
| DIY168117.62-1 | 16 mm | 1 db/pcs |



18,5 cm

| | | |
|--|-------|----------|
| SZIMPLA TARTÓ/ SINGLE BRACKET | | |
| DIY168114.62-1 | 16 mm | 1 db/pcs |



18,5 cm

| | | |
|--|-------|----------|
| DUPLA TARTÓ/ DOUBLE BRACKET | | |
| DIY168115.62-1 | 16 mm | 1 db/pcs |



9,5 cm

| | | |
|---|-------|----------|
| SZIMPLA LAPOS TARTÓ/ SINGLE FLAT BRACKET | | |
| DIY168112.62-1 | 16 mm | 1 db/pcs |



16 cm

| | | |
|---|-------|----------|
| DUPLA LAPOS TARTÓ/ DOUBLE FLAT BRACKET | | |
| DIY168113.62-1 | 16 mm | 1 db/pcs |



**KARIKA RÁNCSZEDŐVEL/
RING WITH HOOK**

| | | |
|-----------------|-------|-----------|
| DIY208081.62-10 | órány | 10 db/pcs |
|-----------------|-------|-----------|



**FÉM KARIKA CSIPESSZEL/
METAL RING WITH CLIPS**

| | | |
|-----------------|--|-----------|
| DIY208083.62-10 | | 10 db/pcs |
|-----------------|--|-----------|



KNICKI-KAMPÓ/KNICKI-HOOK

| | | |
|-----------------|----------|-----------|
| DIY101000.15-10 | átlátszó | 10 db/pcs |
|-----------------|----------|-----------|



2 cm

| | | |
|--|-------|----------|
| OLDALFALI TARTÓ/ ROD SOCKET | | |
| DIY168121.62-2 | 16 mm | 2 db/pcs |



12 cm

| | | |
|---------------------------|-------|----------|
| CSŐTOLDÓ/CONNECTOR | | |
| DIY168017-1 | 16 mm | 1 db/pcs |

Európa 1 soros fémkarnis Ø16 mm - végzáró nélkül
Europe 1 track Ø16 mm metal set - without finials

Európa 2 soros fémkarnis Ø16 mm - végzáró nélkül
Europe 2 track Ø16 mm metal set - without finials



| INOX | |
|-----------------|--------|
| DIY16.07.77.120 | 120 cm |
| DIY16.07.77.160 | 160 cm |
| DIY16.07.77.200 | 200 cm |
| DIY16.07.77.240 | 240 cm |
| DIY16.07.77.300 | 300 cm |

| INOX | |
|-----------------|--------|
| DIY16.77.77.120 | 120 cm |
| DIY16.77.77.160 | 160 cm |
| DIY16.77.77.200 | 200 cm |
| DIY16.77.77.240 | 240 cm |
| DIY16.77.77.300 | 300 cm |



A komplett kiserelés tartalmazza a tartókat (240 cm felett 3 tartó), karikákat ráncsedő kampókkal, valamint a felszereléshez szükséges csavarokat és tipliket.

Including 2 brackets (from 240 cm 3rd bracket) rings and hooks, fixing material (screws and dowels).



5,5 cm

| | | |
|----------------|-------|----------|
| MOHÁCS | | |
| DIY167001.77-2 | 16 mm | 2 db/pcs |



2,5 cm

| | | |
|-----------------|-------|----------|
| VESZPRÉM | | |
| DIY167003.77-2 | 16 mm | 2 db/pcs |



2,5 cm

| | | |
|----------------|-------|----------|
| LISABON | | |
| DIY167004.77-2 | 16 mm | 2 db/pcs |



4 cm

| | | |
|----------------|-------|----------|
| ROMA | | |
| DIY167007.77-2 | 16 mm | 2 db/pcs |



2 cm

| | | |
|----------------|-------|----------|
| VILLÁNY | | |
| DIY167027.77-2 | 16 mm | 2 db/pcs |



5 cm

| | | |
|------------------|-------|----------|
| ROTTERDAM | | |
| DIY167008.77-2 | 16 mm | 2 db/pcs |

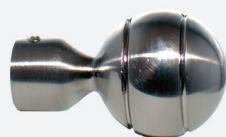

5,5 cm

| | | |
|--------------------|-------|----------|
| NEW ORLEANS | | |
| DIY167031.77-2 | 16 mm | 2 db/pcs |



9,5 cm

| | | |
|--|-------|----------|
| SZIMPLA TARTÓ/ SINGLE BRACKET | | |
| DIY168119.77-1 | 16 mm | 1 db/pcs |

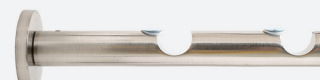

15 cm

| | | |
|--|-------|----------|
| DUPLA TARTÓ/ DOUBLE BRACKET | | |
| DIY168120.77-1 | 16 mm | 1 db/pcs |



| | | |
|---|----------|-----------|
| KARIKA RÁNCSEDŐVEL/ RING WITH HOOK | | |
| DIY208081.77-10 | 16-20 mm | 10 db/pcs |



| | | |
|---|-------|----------|
| SAROKTOLDÓ/ ADJUSTABLE CONNECTOR | | |
| DIY168199.77-1 | 16 mm | 1 db/pcs |



12 cm

| | | |
|---------------------------|-------|----------|
| CSŐTOLDÓ/CONNECTOR | | |
| DIY168017-1 | 16 mm | 1 db/pcs |



| | | |
|----------------------------|----------|-----------|
| RÁNCSEDŐ KAMPÓ/HOOK | | |
| DIY208334.15-10 | átlátszó | 10 db/pcs |

Ø19/16 mm - 2 in 1



Ø19 mm -es fémkarnisok Ø19 mm metal set



France 1 soros fémkarnis Ø19 mm - végzáró nélkül
France 1 track Ø19 mm metal set - without finials



| INOX | |
|-----------------|--------|
| DIY19.06.77.120 | 120 cm |
| DIY19.06.77.160 | 160 cm |
| DIY19.06.77.200 | 200 cm |
| DIY19.06.77.240 | 240 cm |
| DIY19.06.77.300 | 300 cm |

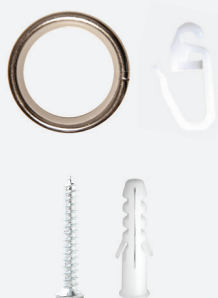

France 2 soros fémkarnis Ø19 mm - végzáró nélkül
France 2 track Ø19 mm metal set - without finials

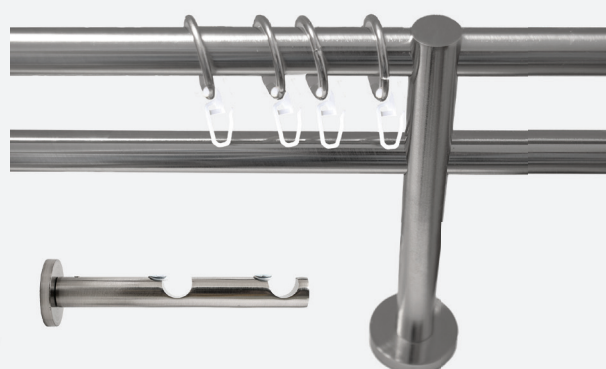

| INOX | |
|-----------------|--------|
| DIY19.66.77.120 | 120 cm |
| DIY19.66.77.160 | 160 cm |
| DIY19.66.77.200 | 200 cm |
| DIY19.66.77.240 | 240 cm |
| DIY19.66.77.300 | 300 cm |

France 1 soros fémkarnis Ø19 mm - végzáró nélkül
France 1 track Ø19 mm metal set - without finials



| TITÁN/TYTAN | |
|-----------------|--------|
| DIY19.06.78.120 | 120 cm |
| DIY19.06.78.160 | 160 cm |
| DIY19.06.78.200 | 200 cm |
| DIY19.06.78.240 | 240 cm |
| DIY19.06.78.300 | 300 cm |



France 2 soros fémkarnis Ø19 mm - végzáró nélkül
France 2 track Ø19 mm metal set - without finials



| TITÁN/TYTAN | |
|-----------------|--------|
| DIY19.66.78.120 | 120 cm |
| DIY19.66.78.160 | 160 cm |
| DIY19.66.78.200 | 200 cm |
| DIY19.66.78.240 | 240 cm |
| DIY19.66.78.300 | 300 cm |

A komplett kiszereelés tartalmazza a tartókat (240 cm felett 3 tartó), karikákat ráncszedő kampókkal, valamint a felszereléshez szükséges csavarokat és tipliket.

Including 2 brackets (from 240 cm 3rd bracket) rings and hooks, fixing material (screws and dowels).

France 1 soros fémkarnis Ø19 mm - végzáró nélkül
France 1 track Ø19 mm metal set - without finials

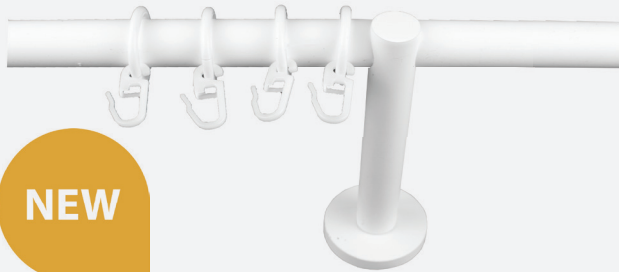

NEW



| FEHÉR/WHITE | |
|-----------------|--------|
| DIY19.30.01.120 | 120 cm |
| DIY19.30.01.160 | 160 cm |
| DIY19.30.01.200 | 200 cm |
| DIY19.30.01.240 | 240 cm |
| DIY19.30.01.300 | 300 cm |



France 2 soros fémkarnis Ø19 mm - végzáró nélkül
France 2 track Ø19 mm metal set - without finials

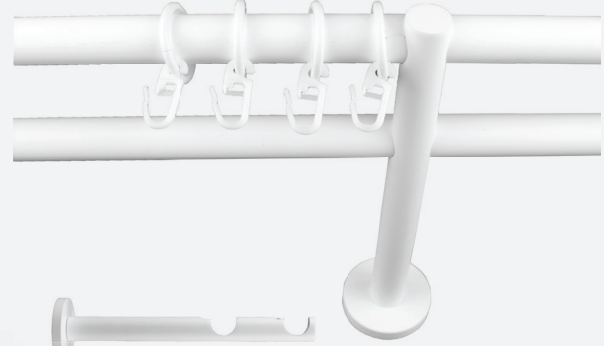

| FEHÉR/WHITE | |
|-----------------|--------|
| DIY19.33.01.120 | 120 cm |
| DIY19.33.01.160 | 160 cm |
| DIY19.33.01.200 | 200 cm |
| DIY19.33.01.240 | 240 cm |
| DIY19.33.01.300 | 300 cm |

France 1 soros fémkarnis Ø19 mm - végzáró nélkül
France 1 track Ø19 mm metal set - without finials



NEW



| FEKETE-MATT/BLACK-MATT | |
|------------------------|--------|
| DIY19.30.21.120 | 120 cm |
| DIY19.30.21.160 | 160 cm |
| DIY19.30.21.200 | 200 cm |
| DIY19.30.21.240 | 240 cm |
| DIY19.30.21.300 | 300 cm |



France 2 soros fémkarnis Ø19 mm - végzáró nélkül
France 2 track Ø19 mm metal set - without finials

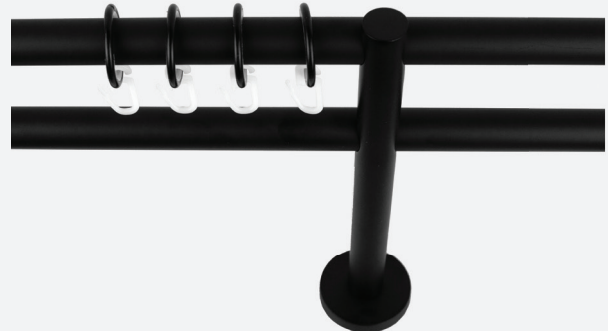

| FEKETE-MATT/BLACK-MATT | |
|------------------------|--------|
| DIY19.33.21.120 | 120 cm |
| DIY19.33.21.160 | 160 cm |
| DIY19.33.21.200 | 200 cm |
| DIY19.33.21.240 | 240 cm |
| DIY19.33.21.300 | 300 cm |

A komplett kiszereelés tartalmazza a tartókat (240 cm felett 3 tartó), karikákat ráncszedő kampókkal, valamint a felszereléshez szükséges csavarokat és tipliket.

Including 2 brackets (from 240 cm 3rd bracket) rings and hooks, fixing material (screws and dowels).

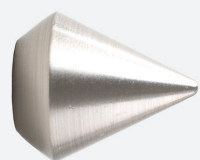

4,3 cm

| METZ | | |
|----------------|-------|----------|
| DIY197014.77-2 | 19 mm | 2 db/pcs |



2 cm

| NANTES | | |
|----------------|-------|----------|
| DIY197010.77-2 | 19 mm | 2 db/pcs |



2,5 cm

| RENNES | | |
|----------------|-------|----------|
| DIY197012.77-2 | 19 mm | 2 db/pcs |

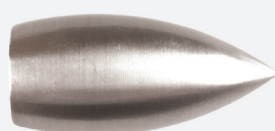

6,3 cm

| ROUEN | | |
|----------------|-------|----------|
| DIY197013.77-2 | 19 mm | 2 db/pcs |

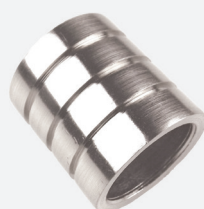

2,6 cm

| TOULON | | |
|----------------|-------|----------|
| DIY197011.77-2 | 19 mm | 2 db/pcs |



5,6 cm

| MONTPELLIER | | |
|----------------|-------|----------|
| DIY197020.77-2 | 19 mm | 2 db/pcs |



13,5 cm

| DUPLA PLAFONTARTÓ/ DOUBLE CEILING BRACKET | | |
|--|-------|----------|
| DIY198118.77-1 | 19 mm | 1 db/pcs |



| KARIKA RÁNCSEDŐVEL/ RING WITH HOOK | | |
|---------------------------------------|------------------|-----------|
| DIY259091.77-10 | szilikon-betétes | 10 db/pcs |



| KARIKA CSIPESSZEL/ RING WITH CLIPS | | |
|---------------------------------------|------------------|-----------|
| DIY259092.77-10 | szilikon-betétes | 10 db/pcs |



2,8 cm

| OLDALFALI TARTÓ/ ROD-SOCKET | | |
|--------------------------------|-------|----------|
| DIY198198.77-1 | 19 mm | 1 db/pcs |



12 cm

| CSŐTOLDÓ/CONNECTOR | | |
|--------------------|-------|----------|
| DIY198017-1 | 19 mm | 1 db/pcs |



13,5 cm

| SZIMPLA TARTÓ/ SINGLE BRACKET | | |
|----------------------------------|-------|----------|
| DIY198119.77-1 | 19 mm | 1 db/pcs |



19,5 cm

| DUPLA TARTÓ/ DOUBLE BRACKET | | |
|--------------------------------|-------|----------|
| DIY198120.77-1 | 19 mm | 1 db/pcs |

A komplett kiserelés tartalmazza a tartókat (240 cm felett 3 tartó), karikákat ráncsedő kampókkal, valamint a felszereléshez szükséges csavarokat és tipliket.

Including 2 brackets (from 240 cm 3rd bracket) rings and hooks, fixing material (screws and dowels).



| NANTES | | |
|----------------|-------|----------|
| DIY197010.78-2 | 19 mm | 2 db/pcs |

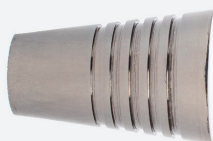

| LORIENT | | |
|----------------|-------|----------|
| DIY197011.78-2 | 19 mm | 2 db/pcs |



| MARSEILLE | | |
|----------------|-------|----------|
| DIY197002.78-2 | 19 mm | 2 db/pcs |

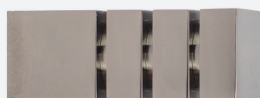

| NIZZA | | |
|----------------|-------|----------|
| DIY197004.78-2 | 19 mm | 2 db/pcs |



| DUPLA PLAFONTARTÓ/ DOUBLE CEILING BRACKET | | |
|--|-------|----------|
| DIY198118.78-1 | 19 mm | 1 db/pcs |



| KARIKA RÁNCSEDŐVEL/ RING WITH HOOK | |
|---------------------------------------|-----------|
| DIY208081.78-10 | 10 db/pcs |



| KARIKA CSIPESSZEL/ RING WITH CLIPS | |
|---------------------------------------|-----------|
| DIY259092.78-10 | 10 db/pcs |



| OLDALFALI TARTÓ/ ROD-SOCKET | | |
|--------------------------------|-------|----------|
| DIY198198.78-1 | 19 mm | 1 db/pcs |



| CSŐTOLDÓ/CONNECTOR | | |
|--------------------|-------|----------|
| DIY198017-1 | 19 mm | 1 db/pcs |



| SZIMPLA TARTÓ/ SINGLE BRACKET | | |
|----------------------------------|-------|----------|
| DIY198119.78-1 | 19 mm | 1 db/pcs |



| DUPLA TARTÓ/ DOUBLE BRACKET | | |
|--------------------------------|-------|----------|
| DIY198120.78-1 | 19 mm | 1 db/pcs |

A komplett kiserelés tartalmazza a tartókat (240 cm felett 3 tartó), karikákat ráncsedő kampókkal, valamint a felszereléshez szükséges csavarokat és tipliket.

Including 2 brackets (from 240 cm 3rd bracket) rings and hooks, fixing material (screws and dowels).

NEW



3 cm

| DIJON | | | |
|----------------|-------|----------|--|
| DIY197015.01-2 | 19 mm | 2 db/pcs | |



2 cm

| NANTES | | | |
|----------------|-------|----------|--|
| DIY197010.01-2 | 19 mm | 2 db/pcs | |



4,8 cm

| PARIS | | | |
|----------------|-------|----------|--|
| DIY197009.01-2 | 19 mm | 2 db/pcs | |

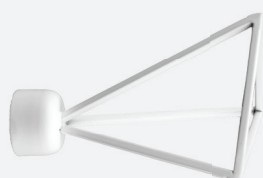

8,9 cm

| REIMS | | | |
|----------------|-------|----------|--|
| DIY197019.01-2 | 19 mm | 2 db/pcs | |



6,1 cm

| AVIGNON | | | |
|----------------|-------|----------|--|
| DIY197016.01-2 | 19 mm | 2 db/pcs | |



13,5 cm

| DUPLA PLAFONTARTÓ/ DOUBLE CEILING BRACKET | | | |
|--|-------|----------|--|
| DIY198118.01-1 | 19 mm | 1 db/pcs | |



| KARIKA RÁNCSEDŐVEL/ RING WITH HOOK | | | |
|---------------------------------------|------------------|-----------|--|
| DIY259091.01-10 | szilikon-betétes | 10 db/pcs | |



| KARIKA CSIPESSZEL/ RING WITH CLIPS | | | |
|---------------------------------------|------------------|-----------|--|
| DIY259092.01-10 | szilikon-betétes | 10 db/pcs | |



2,8 cm

| OLDALFALI TARTÓ/ ROD-SOCKET | | | |
|--------------------------------|-------|----------|--|
| DIY198198.01-1 | 19 mm | 1 db/pcs | |



12 cm

| CSÓTOLDÓ/CONNECTOR | | | |
|--------------------|-------|----------|--|
| DIY198017-1 | 19 mm | 1 db/pcs | |



13,5 cm

| SZIMPLA TARTÓ/ SINGLE BRACKET | | | |
|----------------------------------|-------|----------|--|
| DIY198119.01-1 | 19 mm | 1 db/pcs | |



19,5 cm

| DUPLA TARTÓ/ DOUBLE BRACKET | | | |
|--------------------------------|-------|----------|--|
| DIY198120.01-1 | 19 mm | 1 db/pcs | |

A komplett kiszerelés tartalmazza a tartókat (240 cm felett 3 tartó), karikákat ráncsedő kampókkal, valamint a felszereléshez szükséges csavarokat és tipliket.

Including 2 brackets (from 240 cm 3rd bracket) rings and hooks, fixing material (screws and dowels).

NEW



3 cm

| DIJON | | |
|----------------|-------|----------|
| DIY197015.21-2 | 19 mm | 2 db/pcs |



2 cm

| NANTES | | |
|----------------|-------|----------|
| DIY197010.21-2 | 19 mm | 2 db/pcs |



4,8 cm

| PARIS | | |
|----------------|-------|----------|
| DIY197009.21-2 | 19 mm | 2 db/pcs |



8,9 cm

| REIMS | | |
|----------------|-------|----------|
| DIY197019.21-2 | 19 mm | 2 db/pcs |



2,5 cm

| RENNES | | |
|----------------|-------|----------|
| DIY197012.21-2 | 19 mm | 2 db/pcs |



6,1 cm

| AVIGNON | | |
|----------------|-------|----------|
| DIY197016.21-2 | 19 mm | 2 db/pcs |



13,5 cm

| DUPLA PLAFONTARTÓ/ DOUBLE CEILING BRACKET | | |
|--|-------|----------|
| DIY198118.21-1 | 19 mm | 1 db/pcs |



| KARIKA RÁNCSEDŐVEL/ RING WITH HOOK | | |
|---------------------------------------|------------------|-----------|
| DIY259091.21-10 | szilikon-betétes | 10 db/pcs |



| KARIKA CSIPESSZEL/ RING WITH CLIPS | | |
|---------------------------------------|------------------|-----------|
| DIY259092.21-10 | szilikon-betétes | 10 db/pcs |



2,8 cm

| OLDALFALI TARTÓ/ ROD-SOCKET | | |
|--------------------------------|-------|----------|
| DIY198198.21-1 | 19 mm | 1 db/pcs |

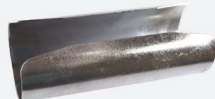

12 cm

| CSŐTOLDÓ/CONNECTOR | | |
|--------------------|-------|----------|
| DIY198017-1 | 19 mm | 1 db/pcs |



13,5 cm

| SZIMPLA TARTÓ/ SINGLE BRACKET | | |
|----------------------------------|-------|----------|
| DIY198119.21-1 | 19 mm | 1 db/pcs |



19,5 cm

| DUPLA TARTÓ/ DOUBLE BRACKET | | |
|--------------------------------|-------|----------|
| DIY198120.21-1 | 19 mm | 1 db/pcs |

A komplett kiserelés tartalmazza a tartókat (240 cm felett 3 tartó), karikákat ráncsedő kampókkal, valamint a felszereléshez szükséges csavarokat és tipliket.

Including 2 brackets (from 240 cm 3rd bracket) rings and hooks, fixing material (screws and dowels).

Ø25 mm -es fémkarnisok
Ø25 mm metal set



Austria 1 soros fémkarnis Ø25 mm - végzáró nélkül
Austria 1 track Ø25 mm metal set - without finials



| NIKKEL-MATT/NICKELL-MATT | |
|--------------------------|--------|
| DIY25.06.40.120 | 120 cm |
| DIY25.06.40.160 | 160 cm |
| DIY25.06.40.200 | 200 cm |
| DIY25.06.40.240 | 240 cm |
| DIY25.06.40.300 | 300 cm |

| ÓARANY/ANTIQUÉ GOLD | |
|---------------------|--------|
| DIY25.06.62.120 | 120 cm |
| DIY25.06.62.160 | 160 cm |
| DIY25.06.62.200 | 200 cm |
| DIY25.06.62.240 | 240 cm |
| DIY25.06.62.300 | 300 cm |

Austria 2 soros fémkarnis Ø25/ Ø16 mm - végzáró nélkül
Austria 2 track Ø25 mm metal set - without finials



| NIKKEL-MATT/NICKELL-MATT | |
|--------------------------|--------|
| DIY25.66.40.120 | 120 cm |
| DIY25.66.40.160 | 160 cm |
| DIY25.66.40.200 | 200 cm |
| DIY25.66.40.240 | 240 cm |
| DIY25.66.40.300 | 300 cm |

| ÓARANY/ANTIQUÉ GOLD | |
|---------------------|--------|
| DIY25.66.62.120 | 120 cm |
| DIY25.66.62.160 | 160 cm |
| DIY25.66.62.200 | 200 cm |
| DIY25.66.62.240 | 240 cm |
| DIY25.66.62.300 | 300 cm |

A komplett kiserelés tartalmazza a tartókat (240 cm felett 3 tartó), karikákat ráncszedő kampókkal, valamint a felszereléshez szükséges csavarokat és tipliket.

Including 2 brackets (from 240 cm 3rd bracket) rings and hooks, fixing material (screws and dowels).



10,5 cm

| | | |
|-----------------|-------|----------|
| SALZBURG | | |
| DIY257006.40-2 | 25 mm | 2 db/pcs |

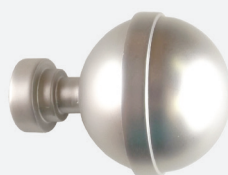

8,5 cm

| | | |
|----------------|-------|----------|
| VILLACH | | |
| DIY257007.40-2 | 25 mm | 2 db/pcs |

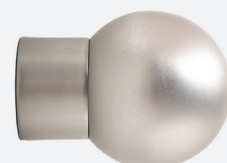

6,5 cm

| | | |
|----------------|-------|----------|
| WIEN | | |
| DIY257008.40-2 | 25 mm | 2 db/pcs |



2 cm

| | | |
|----------------|-------|----------|
| MURAU | | |
| DIY257009.40-2 | 25 mm | 2 db/pcs |



7,5 cm

| | | |
|--------------------|-------|----------|
| NICKELSDORF | | |
| DIY257011.40-2 | 25 mm | 2 db/pcs |



14 cm

| | | |
|--|-------|----------|
| SZIMPLA TARTÓ/ SINGLE BRACKET | | |
| DIY258114.40-1 | 25 mm | 1 db/pcs |



20,5 cm

| | | |
|--|-------|----------|
| DUPLA TARTÓ/ DOUBLE BRACKET | | |
| DIY258115.40-1 | 25 mm | 1 db/pcs |



12 cm

| | | |
|---------------------------|-------|----------|
| CSŐTOLDÓ/CONNECTOR | | |
| DIY258017-1 | 25 mm | 1 db/pcs |



| | | |
|---|-----|-----------|
| KARIKA RÁNCSEDŐVEL/ RING WITH HOOK | | |
| DIY259090.40-10 | fém | 10 db/pcs |



| | | |
|--|-----|-----------|
| KARIKA CSIPESSZEL/ RING WITH CLIP | | |
| DIY259091.40-10 | fém | 10 db/pcs |



3 cm

| | | |
|------------------------------------|-------|----------|
| OLDALFALI TARTÓ/ ROD-SOCKET | | |
| DIY258121.40-2 | 25 mm | 2 db/pcs |

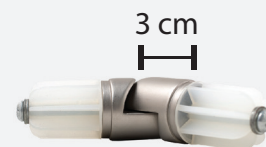

3 cm

| | | |
|---|-------|----------|
| SAROKTOLDÓ/ ADJUSTABLE CONNECTOR | | |
| DIY258199.40-1 | 25 mm | 1 db/pcs |



| | | |
|-----------------------------|-------|-----------|
| RÁNCSEDŐ KAMPÓ/ HOOK | | |
| DIY208335.15-10 | 25 mm | 10 db/pcs |



10,5 cm

SALZBURG

DIY257006.62-2 25 mm 2 db/pcs

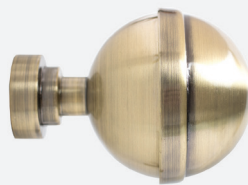

8,5 cm

VILLACH

DIY257007.62-2 25 mm 2 db/pcs



6,5 cm

WIEN

DIY257008.62-2 25 mm 2 db/pcs



2 cm

MURAU

DIY257009.62-2 25 mm 2 db/pcs

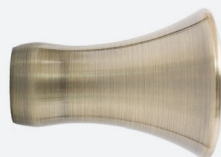

7,5 cm

NICKELSDORF

DIY257011.62-2 25 mm 2 db/pcs



14 cm

**SZIMPLA TARTÓ/
SINGLE BRACKET**

DIY258114.62-1 25 mm 1 db/pcs



20,5 cm

**DUPLA TARTÓ/
DOUBLE BRACKET**

DIY258115.62-1 25 mm 1 db/pcs



12 cm

CSŐTOLDÓ/CONNECTOR

DIY258017-1 25 mm 1 db/pcs



**KARIKA RÁNCSEDŐVEL/
RING WITH HOOK**

DIY259090.62-10 fém 10 db/pcs



**KARIKA CSIPESSZEL/
RING WITH CLIP**

DIY259091.62-10 fém 10 db/pcs



3 cm

OLDALFALI TARTÓ/ ROD-SOCKET

DIY258121.62-2 25 mm 2 db/pcs



3 cm

**SAROKTOLDÓ/
ADJUSTABLE CONNECTOR**

DIY258199.62-1 25 mm 1 db/pcs



RÁNCSEDŐ KAMPÓ/ HOOK

DIY208335.15-10 25 mm 10 db/pcs

NEW

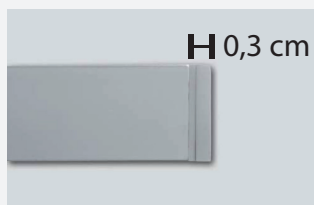
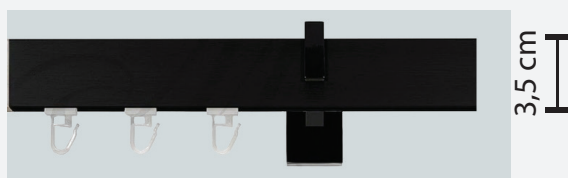

| VÉGZÁRÓ-KESKENY (INOX/FEKETE)/ SIDE COVER-NARROW (INOX/BLACK) | | |
|--|--------------|----------|
| DIY188001.77-2 | inox/inox | 2 db/pcs |
| DIY188001.21-2 | fekete/black | 2 db/pcs |

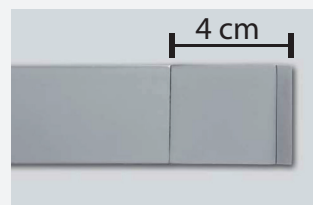

| VÉGZÁRÓ-SZÉLES (INOX/FEKETE)/ SIDE COVER-WIDE (INOX/BLACK) | | |
|---|--------------|----------|
| DIY188002.77-2 | inox/inox | 2 db/pcs |
| DIY188002.21-2 | fekete/black | 2 db/pcs |



| SQUARE PROFIL (INOX/FEKETE)/(INOX/BLACK) | | |
|--|--------------|--------|
| 188080.77-120 | inox/inox | 120 cm |
| 188080.77-160 | inox/inox | 160 cm |
| 188080.77-200 | inox/inox | 200 cm |
| 188080.77-240 | inox/inox | 240 cm |
| 188080.77-300 | inox/inox | 300 cm |
| 188080.77-400 | inox/inox | 400 cm |
| 188080.21-120 | fekete/black | 120 cm |
| 188080.21-160 | fekete/black | 160 cm |
| 188080.21-200 | fekete/black | 200 cm |
| 188080.21-240 | fekete/black | 240 cm |
| 188080.21-300 | fekete/black | 300 cm |
| 188080.21-400 | fekete/black | 400 cm |



| OLDALFALI TARTÓ/ANGLE BRACKET | | |
|-------------------------------|--------------|----------|
| DIY188121.77-1 | inox/inox | 1 db/pcs |
| DIY188121.21-1 | fekete/black | 1 db/pcs |

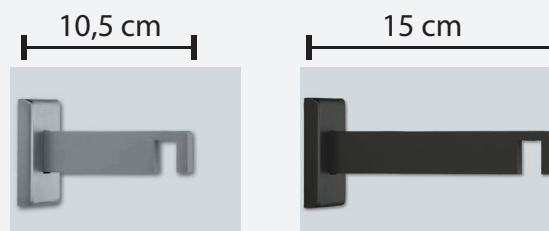

| SZIMPLA TARTÓ/SINGLE BRACKET | | | |
|------------------------------|-------------|--------------|----------|
| DIY188118.77-1 | rövid/short | inox/inox | 1 db/pcs |
| DIY188118.21-1 | rövid/short | fekete/black | 1 db/pcs |
| DIY188119.77-1 | hosszú/long | inox/inox | 1 db/pcs |
| DIY188119.21-1 | hosszú/long | fekete/black | 1 db/pcs |

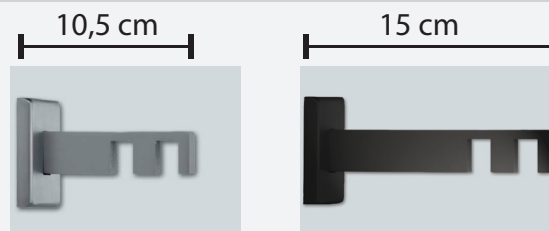

| DUPLA TARTÓ/DOUBLE BRACKET | | | |
|----------------------------|-------------|--------------|----------|
| DIY188128.77-1 | rövid/short | inox/inox | 1 db/pcs |
| DIY188128.21-1 | rövid/short | fekete/black | 1 db/pcs |
| DIY188129.77-1 | hosszú/long | inox/inox | 1 db/pcs |
| DIY188129.21-1 | hosszú/long | fekete/black | 1 db/pcs |

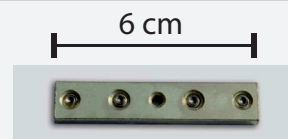

| TOLDÓ/CONNECTOR | |
|-----------------|----------|
| DIY188017-1 | 1 db/pcs |

| TARTOZÉKCSOMAGOK 1 SOROS PROFILHOZ/ ACCESSORY BAG FOR 1 TRACK PROFILE | | |
|--|--------------------------------|-----------------------------|
| DIY10.81.120.T | 1 soros 120 cm/ 1 track 120 cm | T-csúszkával/ with T-glider |
| DIY10.81.120.X | 1 soros 120 cm/ 1 track 120 cm | X-csúszkával/ with X-glider |
| DIY10.81.160.T | 1 soros 160 cm/ 1 track 160 cm | T-csúszkával/ with T-glider |
| DIY10.81.160.X | 1 soros 160 cm/ 1 track 160 cm | X-csúszkával/ with X-glider |
| DIY10.81.200.T | 1 soros 200 cm/ 1 track 200 cm | T-csúszkával/ with T-glider |
| DIY10.81.200.X | 1 soros 200 cm/ 1 track 200 cm | X-csúszkával/ with X-glider |
| DIY10.81.240.T | 1 soros 240 cm/ 1 track 240 cm | T-csúszkával/ with T-glider |
| DIY10.81.240.X | 1 soros 240 cm/ 1 track 240 cm | X-csúszkával/ with X-glider |
| DIY10.81.300.T | 1 soros 300 cm/ 1 track 300 cm | T-csúszkával/ with T-glider |
| DIY10.81.300.X | 1 soros 300 cm/ 1 track 300 cm | X-csúszkával/ with X-glider |
| DIY10.81.400.T | 1 soros 400 cm/ 1 track 400 cm | T-csúszkával/ with T-glider |
| DIY10.81.400.X | 1 soros 400 cm/ 1 track 400 cm | X-csúszkával/ with X-glider |

| TARTOZÉKCSOMAGOK 2 SOROS PROFILHOZ/ ACCESSORY BAG FOR 2 TRACK PROFILE | | |
|--|--------------------------------|-----------------------------|
| DIY10.82.120.T | 2 soros 120 cm/ 2 track 120 cm | T-csúszkával/ with T-glider |
| DIY10.82.120.X | 2 soros 120 cm/ 2 track 120 cm | X-csúszkával/ with X-glider |
| DIY10.82.160.T | 2 soros 160 cm/ 2 track 160 cm | T-csúszkával/ with T-glider |
| DIY10.82.160.X | 2 soros 160 cm/ 2 track 160 cm | X-csúszkával/ with X-glider |
| DIY10.82.200.T | 2 soros 200 cm/ 2 track 200 cm | T-csúszkával/ with T-glider |
| DIY10.82.200.X | 2 soros 200 cm/ 2 track 200 cm | X-csúszkával/ with X-glider |
| DIY10.82.240.T | 2 soros 240 cm/ 2 track 240 cm | T-csúszkával/ with T-glider |
| DIY10.82.240.X | 2 soros 240 cm/ 2 track 240 cm | X-csúszkával/ with X-glider |
| DIY10.82.300.T | 2 soros 300 cm/ 2 track 300 cm | T-csúszkával/ with T-glider |
| DIY10.82.300.X | 2 soros 300 cm/ 2 track 300 cm | X-csúszkával/ with X-glider |
| DIY10.82.400.T | 2 soros 400 cm/ 2 track 400 cm | T-csúszkával/ with T-glider |
| DIY10.82.400.X | 2 soros 400 cm/ 2 track 400 cm | X-csúszkával/ with X-glider |



Filigrano karnisok,
pótsínek
és tartozékaik

Filigrano curtain rods,
U-track
& accessories

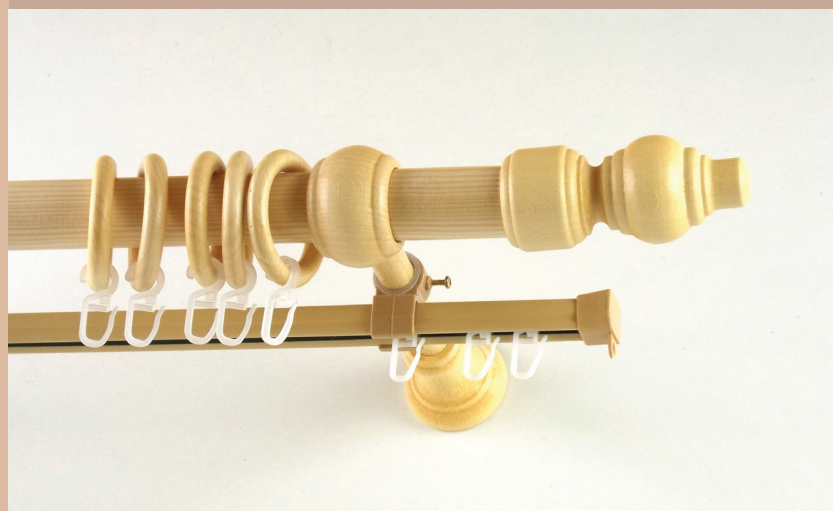

FILIGRANO műanyag karnis Ø28 mm
Filigrano plastic Ø28 mm

FILIGRANO műanyag karnis Ø28 mm pótsínnel
Filigrano plastic Ø28 mm + U-track

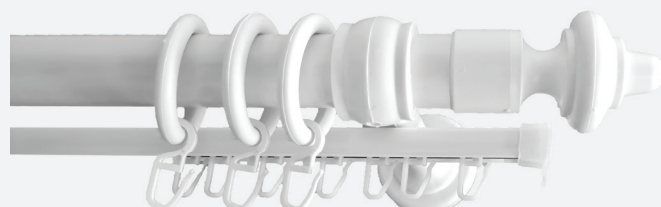

| FEHÉR/WHITE | |
|-----------------|--------|
| DIY28.11.01.120 | 120 cm |
| DIY28.11.01.140 | 140 cm |
| DIY28.11.01.160 | 160 cm |
| DIY28.11.01.180 | 180 cm |
| DIY28.11.01.200 | 200 cm |
| DIY28.11.01.220 | 220 cm |
| DIY28.11.01.240 | 240 cm |
| DIY28.11.01.260 | 260 cm |
| DIY28.11.01.280 | 280 cm |
| DIY28.11.01.300 | 300 cm |

| FEHÉR/WHITE | |
|-----------------|--------|
| DIY28.30.01.120 | 120 cm |
| DIY28.30.01.140 | 140 cm |
| DIY28.30.01.160 | 160 cm |
| DIY28.30.01.180 | 180 cm |
| DIY28.30.01.200 | 200 cm |
| DIY28.30.01.220 | 220 cm |
| DIY28.30.01.240 | 240 cm |
| DIY28.30.01.260 | 260 cm |
| DIY28.30.01.280 | 280 cm |
| DIY28.30.01.300 | 300 cm |

Tartozékok/Accessories

| | | | |
|---|---|--|---|
|  |  |  |  |
| 16 cm | 7,8 cm | | |
| TARTÓ/BRACKET | VÉGZÁRÓ/FINIAL | KARIKA RÁNCSEDŐVEL/ RING WITH HOOK | RÁNCSEDŐ KAMPÓ/HOOK |
| DIY288111.01-1 28 mm 1 db/pcs | DIY288009.01-2 28 mm 2 db/pcs | DIY288081.01-10 28 mm 10 db/pcs | DIY288330.15-10 25 mm 10 db/pcs |

| | | | |
|---|---|--|---|
|  |  |  |  |
| GÖRGŐ RÁNCSEDŐVEL/HOOK | VÉGZÁRÓ + TARTÓ 2+2 DB/PCS/ END CAP+BRACKET | GÖRGŐ CSIPESSZEL/ RUNNER WITH CLIP | KÖZBENSŐ LEZÁRÓ/CLOSING |
| DIY301001-10 10 db/pcs | DIY309024.15-4 átlátszó | DIY309903-10 10 db/pcs | DIY104016-6 6 db/pcs |
| DIY301001-20 20 db/pcs | | DIY309903-20 20 db/pcs | |

FILIGRANO fa karnis - Ø28 mm

Filigrano wood Ø28 mm

NEW



| SZÜRKE/GRAY | |
|-----------------|--------|
| DIY28.11.12.120 | 120 cm |
| DIY28.11.12.140 | 140 cm |
| DIY28.11.12.160 | 160 cm |
| DIY28.11.12.180 | 180 cm |
| DIY28.11.12.200 | 200 cm |
| DIY28.11.12.220 | 220 cm |
| DIY28.11.12.240 | 240 cm |
| DIY28.11.12.260 | 260 cm |
| DIY28.11.12.280 | 280 cm |
| DIY28.11.12.300 | 300 cm |



| NATÚR/NATUR | |
|-----------------|--------|
| DIY28.11.17.120 | 120 cm |
| DIY28.11.17.140 | 140 cm |
| DIY28.11.17.160 | 160 cm |
| DIY28.11.17.180 | 180 cm |
| DIY28.11.17.200 | 200 cm |
| DIY28.11.17.220 | 220 cm |
| DIY28.11.17.240 | 240 cm |
| DIY28.11.17.260 | 260 cm |
| DIY28.11.17.280 | 280 cm |
| DIY28.11.17.300 | 300 cm |



| VILÁGOS TÖLGY/OAK LIGHT | |
|-------------------------|--------|
| DIY28.11.16.120 | 120 cm |
| DIY28.11.16.140 | 140 cm |
| DIY28.11.16.160 | 160 cm |
| DIY28.11.16.180 | 180 cm |
| DIY28.11.16.200 | 200 cm |
| DIY28.11.16.220 | 220 cm |
| DIY28.11.16.240 | 240 cm |
| DIY28.11.16.260 | 260 cm |
| DIY28.11.16.280 | 280 cm |
| DIY28.11.16.300 | 300 cm |



| DIÓ/WALNUT | |
|-----------------|--------|
| DIY28.11.19.120 | 120 cm |
| DIY28.11.19.140 | 140 cm |
| DIY28.11.19.160 | 160 cm |
| DIY28.11.19.180 | 180 cm |
| DIY28.11.19.200 | 200 cm |
| DIY28.11.19.220 | 220 cm |
| DIY28.11.19.240 | 240 cm |
| DIY28.11.19.260 | 260 cm |
| DIY28.11.19.280 | 280 cm |
| DIY28.11.19.300 | 300 cm |



| MAHAGÓNI/MAHAGONY | |
|-------------------|--------|
| DIY28.11.20.120 | 120 cm |
| DIY28.11.20.140 | 140 cm |
| DIY28.11.20.160 | 160 cm |
| DIY28.11.20.180 | 180 cm |
| DIY28.11.20.200 | 200 cm |
| DIY28.11.20.220 | 220 cm |
| DIY28.11.20.240 | 240 cm |
| DIY28.11.20.260 | 260 cm |
| DIY28.11.20.280 | 280 cm |
| DIY28.11.20.300 | 300 cm |



| CSERESZNYE/CHERRY-TREE | |
|------------------------|--------|
| DIY28.11.22.120 | 120 cm |
| DIY28.11.22.140 | 140 cm |
| DIY28.11.22.160 | 160 cm |
| DIY28.11.22.180 | 180 cm |
| DIY28.11.22.200 | 200 cm |
| DIY28.11.22.220 | 220 cm |
| DIY28.11.22.240 | 240 cm |
| DIY28.11.22.260 | 260 cm |
| DIY28.11.22.280 | 280 cm |
| DIY28.11.22.300 | 300 cm |

FILIGRANO fa karnis - Ø28 mm pótsínnel

Filigrano wood Ø28 mm + U-track

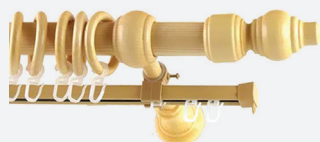

| NATÚR/NATUR | |
|-----------------|--------|
| DIY28.30.17.120 | 120 cm |
| DIY28.30.17.140 | 140 cm |
| DIY28.30.17.160 | 160 cm |
| DIY28.30.17.180 | 180 cm |
| DIY28.30.17.200 | 200 cm |
| DIY28.30.17.220 | 220 cm |
| DIY28.30.17.240 | 240 cm |
| DIY28.30.17.260 | 260 cm |
| DIY28.30.17.280 | 280 cm |
| DIY28.30.17.300 | 300 cm |

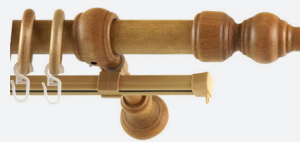

| VILÁGOS TÖLGY/OAK LIGHT | |
|-------------------------|--------|
| DIY28.30.16.120 | 120 cm |
| DIY28.30.16.140 | 140 cm |
| DIY28.30.16.160 | 160 cm |
| DIY28.30.16.180 | 180 cm |
| DIY28.30.16.200 | 200 cm |
| DIY28.30.16.220 | 220 cm |
| DIY28.30.16.240 | 240 cm |
| DIY28.30.16.260 | 260 cm |
| DIY28.30.16.280 | 280 cm |
| DIY28.30.16.300 | 300 cm |



| CSERESZNYE/CHERRY-TREE | |
|------------------------|--------|
| DIY28.30.22.120 | 120 cm |
| DIY28.30.22.140 | 140 cm |
| DIY28.30.22.160 | 160 cm |
| DIY28.30.22.180 | 180 cm |
| DIY28.30.22.200 | 200 cm |
| DIY28.30.22.220 | 220 cm |
| DIY28.30.22.240 | 240 cm |
| DIY28.30.22.260 | 260 cm |
| DIY28.30.22.280 | 280 cm |
| DIY28.30.22.300 | 300 cm |



| MAHAGÓNI/MAHAGONY | |
|-------------------|--------|
| DIY28.30.20.120 | 120 cm |
| DIY28.30.20.140 | 140 cm |
| DIY28.30.20.160 | 160 cm |
| DIY28.30.20.180 | 180 cm |
| DIY28.30.20.200 | 200 cm |
| DIY28.30.20.220 | 220 cm |
| DIY28.30.20.240 | 240 cm |
| DIY28.30.20.260 | 260 cm |
| DIY28.30.20.280 | 280 cm |
| DIY28.30.20.300 | 300 cm |



| DIÓ/WALNUT | |
|-----------------|--------|
| DIY28.30.19.120 | 120 cm |
| DIY28.30.19.140 | 140 cm |
| DIY28.30.19.160 | 160 cm |
| DIY28.30.19.180 | 180 cm |
| DIY28.30.19.200 | 200 cm |
| DIY28.30.19.220 | 220 cm |
| DIY28.30.19.240 | 240 cm |
| DIY28.30.19.260 | 260 cm |
| DIY28.30.19.280 | 280 cm |
| DIY28.30.19.300 | 300 cm |

Tartozékok/Accessories

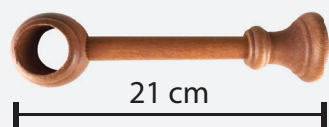

| TARTÓ/BRACKET | | | |
|----------------|-------|----------|--|
| DIY288111.12-1 | 28 mm | 1 db/pcs | |
| DIY288111.16-1 | 28 mm | 1 db/pcs | |
| DIY288111.17-1 | 28 mm | 1 db/pcs | |
| DIY288111.19-1 | 28 mm | 1 db/pcs | |
| DIY288111.20-1 | 28 mm | 1 db/pcs | |
| DIY288111.22-1 | 28 mm | 1 db/pcs | |

| DUPLA TARTÓ/BRACKET | | | |
|---------------------|-------|----------|--|
| SB 288225.12-1 | 28 mm | 1 db/pcs | |
| SB 288225.16-1 | 28 mm | 1 db/pcs | |
| SB 288225.17-1 | 28 mm | 1 db/pcs | |
| SB 288225.19-1 | 28 mm | 1 db/pcs | |
| SB 288225.20-1 | 28 mm | 1 db/pcs | |
| SB 288225.22-1 | 28 mm | 1 db/pcs | |

| VÉGZÁRÓ/FINIAL | | | |
|----------------|-------|----------|--|
| DIY288009.12-2 | 28 mm | 2 db/pcs | |
| DIY288009.16-2 | 28 mm | 2 db/pcs | |
| DIY288009.17-2 | 28 mm | 2 db/pcs | |
| DIY288009.19-2 | 28 mm | 2 db/pcs | |
| DIY288009.20-2 | 28 mm | 2 db/pcs | |
| DIY288009.22-2 | 28 mm | 2 db/pcs | |

| KARIKA RÁNCSEDŐVEL/ RING WITH HOOK | | | |
|---------------------------------------|-------|-----------|--|
| DIY288081.12-10 | 28 mm | 10 db/pcs | |
| DIY288081.16-10 | 28 mm | 10 db/pcs | |
| DIY288081.17-10 | 28 mm | 10 db/pcs | |
| DIY288081.19-10 | 28 mm | 10 db/pcs | |
| DIY288081.20-10 | 28 mm | 10 db/pcs | |
| DIY288081.22-10 | 28 mm | 10 db/pcs | |

U-Sín Standard (fém, műanyag alkatrészekkel)

U-track Standard



| FEHÉR/WHITE | |
|-----------------|--------|
| DIY30.10.01.110 | 110 cm |
| DIY30.10.01.130 | 130 cm |
| DIY30.10.01.150 | 150 cm |
| DIY30.10.01.170 | 170 cm |
| DIY30.10.01.190 | 190 cm |
| DIY30.10.01.210 | 210 cm |
| DIY30.10.01.230 | 230 cm |
| DIY30.10.01.250 | 250 cm |
| DIY30.10.01.270 | 270 cm |
| DIY30.10.01.290 | 290 cm |



| BRONZ/BRONZE | |
|-----------------|--------|
| DIY30.10.02.110 | 110 cm |
| DIY30.10.02.130 | 130 cm |
| DIY30.10.02.150 | 150 cm |
| DIY30.10.02.170 | 170 cm |
| DIY30.10.02.190 | 190 cm |
| DIY30.10.02.210 | 210 cm |
| DIY30.10.02.230 | 230 cm |
| DIY30.10.02.250 | 250 cm |
| DIY30.10.02.270 | 270 cm |
| DIY30.10.02.290 | 290 cm |

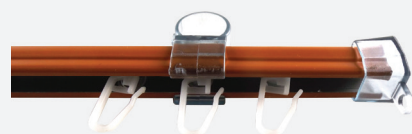

| TERRAKOTTA/TERRACOTTA | |
|-----------------------|--------|
| DIY30.10.05.110 | 110 cm |
| DIY30.10.05.130 | 130 cm |
| DIY30.10.05.150 | 150 cm |
| DIY30.10.05.170 | 170 cm |
| DIY30.10.05.190 | 190 cm |
| DIY30.10.05.210 | 210 cm |
| DIY30.10.05.230 | 230 cm |
| DIY30.10.05.250 | 250 cm |
| DIY30.10.05.270 | 270 cm |
| DIY30.10.05.290 | 290 cm |

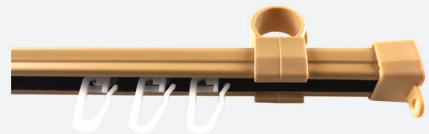

| BEIGE | |
|-----------------|--------|
| DIY30.10.03.110 | 110 cm |
| DIY30.10.03.130 | 130 cm |
| DIY30.10.03.150 | 150 cm |
| DIY30.10.03.170 | 170 cm |
| DIY30.10.03.190 | 190 cm |
| DIY30.10.03.210 | 210 cm |
| DIY30.10.03.230 | 230 cm |
| DIY30.10.03.250 | 250 cm |
| DIY30.10.03.270 | 270 cm |
| DIY30.10.03.290 | 290 cm |

Mennyezeti sínek és tartozékaik

Ceiling tracks & accessories



Stuttgart 1 soros műanyag mennyezeti sín - tartozék nélkül
Stuttgart 1 track Ceiling track without accessories

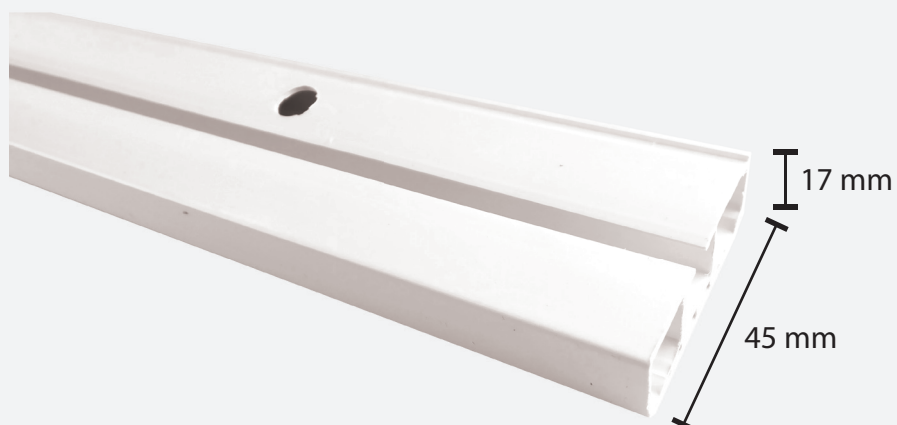

| FEHÉR/WHITE | | |
|-----------------|-----------------|--------|
| DIY10.10.01.120 | 1 soros/1 track | 120 cm |
| DIY10.10.01.150 | 1 soros/1 track | 150 cm |
| DIY10.10.01.180 | 1 soros/1 track | 180 cm |
| DIY10.10.01.210 | 1 soros/1 track | 210 cm |
| DIY10.10.01.250 | 1 soros/1 track | 250 cm |
| DIY10.10.01.300 | 1 soros/1 track | 300 cm |
| DIY10.10.01.600 | 1 soros/1 track | 600 cm |

Stuttgart 2 soros műanyag mennyezeti sín - tartozék nélkül
Stuttgart 2 track Ceiling track without accessories



| FEHÉR/WHITE | | |
|-----------------|------------------|--------|
| DIY10.20.01.120 | 2 soros/2 tracks | 120 cm |
| DIY10.20.01.150 | 2 soros/2 tracks | 150 cm |
| DIY10.20.01.180 | 2 soros/2 tracks | 180 cm |
| DIY10.20.01.210 | 2 soros/2 tracks | 210 cm |
| DIY10.20.01.250 | 2 soros/2 tracks | 250 cm |
| DIY10.20.01.300 | 2 soros/2 tracks | 300 cm |
| DIY10.20.01.600 | 2 soros/2 tracks | 600 cm |

Stuttgart 3 soros műanyag mennyezeti sín - tartozék nélkül
Stuttgart 3 track Ceiling track without accessories

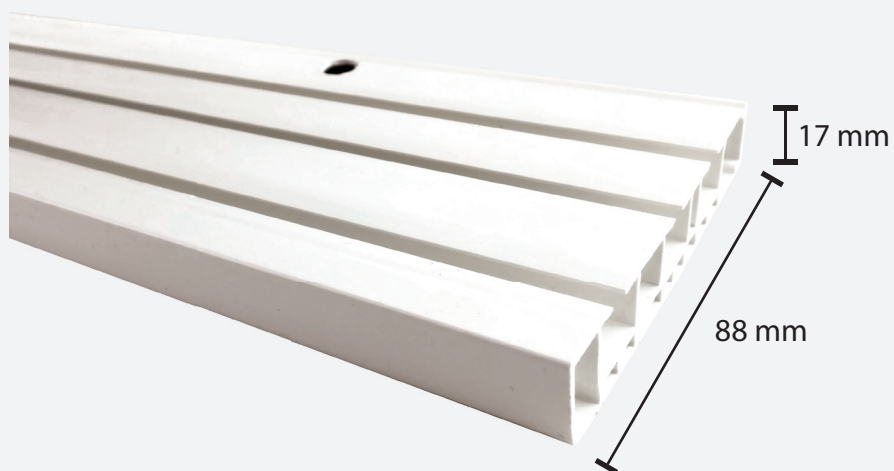

| FEHÉR/WHITE | | |
|-----------------|------------------|--------|
| DIY10.30.01.120 | 3 soros/3 tracks | 120 cm |
| DIY10.30.01.150 | 3 soros/3 tracks | 150 cm |
| DIY10.30.01.180 | 3 soros/3 tracks | 180 cm |
| DIY10.30.01.210 | 3 soros/3 tracks | 210 cm |
| DIY10.30.01.250 | 3 soros/3 tracks | 250 cm |
| DIY10.30.01.300 | 3 soros/3 tracks | 300 cm |
| DIY10.30.01.600 | 3 soros/3 tracks | 600 cm |

Stuttgart 1 soros fekete műanyag mennyezeti sín - tartozék nélkül
Stuttgart 1 track black Ceiling track without accessories



| FEKETE/BLACK | | |
|-----------------|-----------------|--------|
| DIY10.10.21.120 | 1 soros/1 track | 120 cm |
| DIY10.10.21.150 | 1 soros/1 track | 150 cm |
| DIY10.10.21.180 | 1 soros/1 track | 180 cm |
| DIY10.10.21.210 | 1 soros/1 track | 210 cm |
| DIY10.10.21.250 | 1 soros/1 track | 250 cm |
| DIY10.10.21.300 | 1 soros/1 track | 300 cm |
| DIY10.10.21.600 | 1 soros/1 track | 600 cm |

Stuttgart 2 soros fekete műanyag mennyezeti sín - tartozék nélkül
Stuttgart 2 track black Ceiling track without accessories

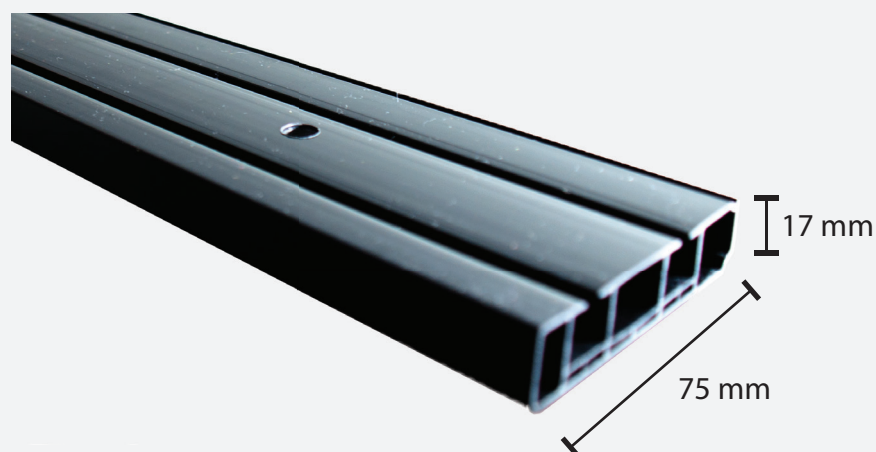

| FEKETE/BLACK | | |
|-----------------|-----------------|--------|
| DIY10.20.21.120 | 2 soros/2 track | 120 cm |
| DIY10.20.21.150 | 2 soros/2 track | 150 cm |
| DIY10.20.21.180 | 2 soros/2 track | 180 cm |
| DIY10.20.21.210 | 2 soros/2 track | 210 cm |
| DIY10.20.21.250 | 2 soros/2 track | 250 cm |
| DIY10.20.21.300 | 2 soros/2 track | 300 cm |
| DIY10.20.21.600 | 2 soros/2 track | 600 cm |

München 1 soros műanyag mennyezeti sín - tartozékcsomaggal
München 1 track Ceiling track with accessorie bag

| FEHÉR/WHITE | | |
|-----------------|-----------------|--------|
| DIY10.11.01.120 | 1 soros/1 track | 120 cm |
| DIY10.11.01.150 | 1 soros/1 track | 150 cm |
| DIY10.11.01.180 | 1 soros/1 track | 180 cm |
| DIY10.11.01.210 | 1 soros/1 track | 210 cm |
| DIY10.11.01.250 | 1 soros/1 track | 250 cm |
| DIY10.11.01.300 | 1 soros/1 track | 300 cm |



München 2 soros műanyag mennyezeti sín - tartozékcsomaggal
München 2 track Ceiling track with accessorie bag

| FEHÉR/WHITE | | |
|-----------------|-----------------|--------|
| DIY10.21.01.120 | 2 soros/2 track | 120 cm |
| DIY10.21.01.150 | 2 soros/2 track | 150 cm |
| DIY10.21.01.180 | 2 soros/2 track | 180 cm |
| DIY10.21.01.210 | 2 soros/2 track | 210 cm |
| DIY10.21.01.250 | 2 soros/2 track | 250 cm |
| DIY10.21.01.300 | 2 soros/2 track | 300 cm |



München 3 soros műanyag mennyezeti sín - tartozékcsomaggal
München 3 track Ceiling track with accessorie bag

| FEHÉR/WHITE | | |
|-----------------|------------------|--------|
| DIY10.31.01.120 | 3 soros/3 tracks | 120 cm |
| DIY10.31.01.150 | 3 soros/3 tracks | 150 cm |
| DIY10.31.01.180 | 3 soros/3 tracks | 180 cm |
| DIY10.31.01.210 | 3 soros/3 tracks | 210 cm |
| DIY10.31.01.250 | 3 soros/3 tracks | 250 cm |
| DIY10.31.01.300 | 3 soros/3 tracks | 300 cm |

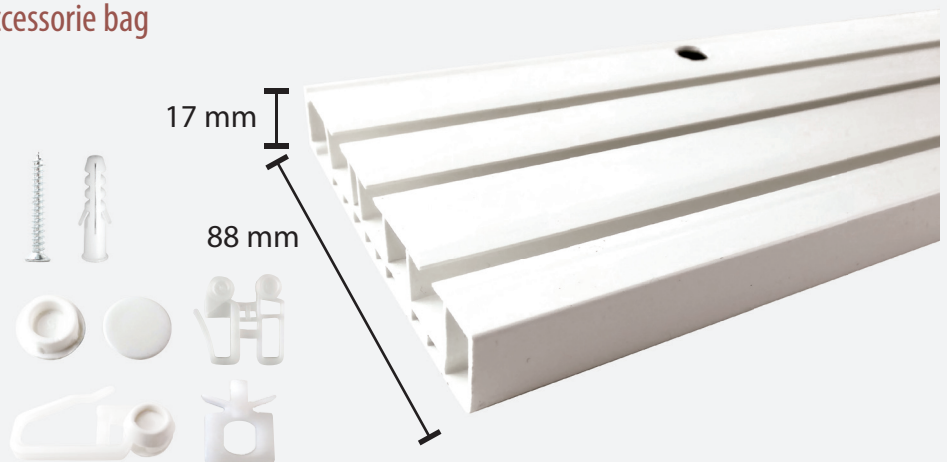

München 1 soros fekete műanyag mennyezeti sín - tartozéksomaggal
München 1 track black Ceiling track with accessorie bag



| FEKETE/BLACK | | |
|-----------------|-----------------|--------|
| DIY10.11.21.120 | 1 soros/1 track | 120 cm |
| DIY10.11.21.150 | 1 soros/1 track | 150 cm |
| DIY10.11.21.180 | 1 soros/1 track | 180 cm |
| DIY10.11.21.210 | 1 soros/1 track | 210 cm |
| DIY10.11.21.250 | 1 soros/1 track | 250 cm |
| DIY10.11.21.300 | 1 soros/1 track | 300 cm |

München 2 soros fekete műanyag mennyezeti sín - tartozéksomaggal
München 2 track black Ceiling track with accessorie bag

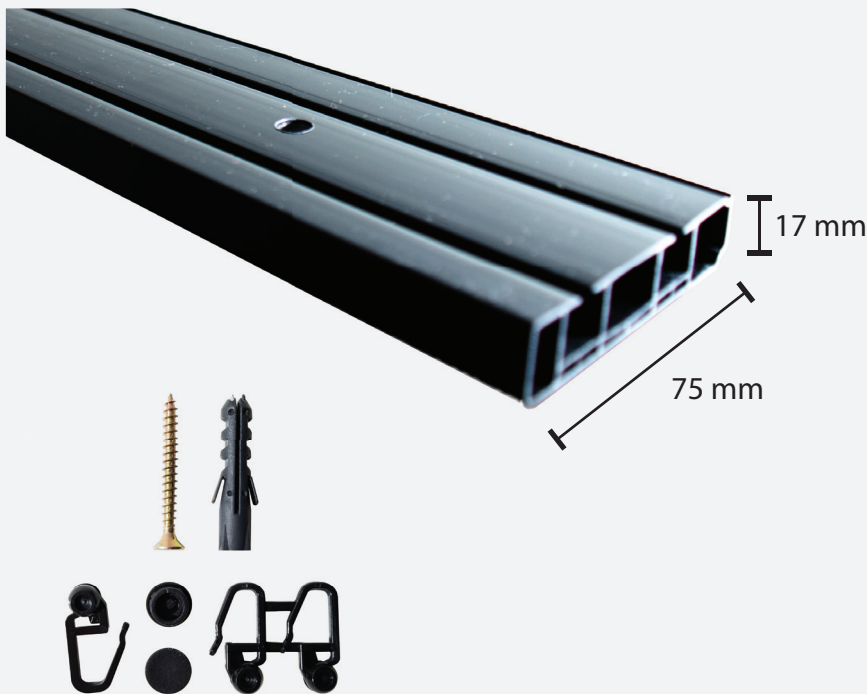

| FEKETE/BLACK | | |
|-----------------|-----------------|--------|
| DIY10.21.21.120 | 2 soros/2 track | 120 cm |
| DIY10.21.21.150 | 2 soros/2 track | 150 cm |
| DIY10.21.21.180 | 2 soros/2 track | 180 cm |
| DIY10.21.21.210 | 2 soros/2 track | 210 cm |
| DIY10.21.21.250 | 2 soros/2 track | 250 cm |
| DIY10.21.21.300 | 2 soros/2 track | 300 cm |



| FEHÉR/WHITE | | |
|-----------------|------------------|--------|
| DIY10.12.01.120 | 1 soros/1 track | 120 cm |
| DIY10.12.01.150 | 1 soros/1 track | 150 cm |
| DIY10.12.01.180 | 1 soros/1 track | 180 cm |
| DIY10.12.01.210 | 1 soros/1 track | 210 cm |
| DIY10.12.01.250 | 1 soros/1 track | 250 cm |
| DIY10.12.01.300 | 1 soros/1 track | 300 cm |
| DIY10.22.01.120 | 2 soros/2 tracks | 120 cm |
| DIY10.22.01.150 | 2 soros/2 tracks | 150 cm |
| DIY10.22.01.180 | 2 soros/2 tracks | 180 cm |
| DIY10.22.01.210 | 2 soros/2 tracks | 210 cm |
| DIY10.22.01.250 | 2 soros/2 tracks | 250 cm |
| DIY10.22.01.300 | 2 soros/2 tracks | 300 cm |
| DIY10.32.01.120 | 3 soros/3 tracks | 120 cm |
| DIY10.32.01.150 | 3 soros/3 tracks | 150 cm |
| DIY10.32.01.180 | 3 soros/3 tracks | 180 cm |
| DIY10.32.01.210 | 3 soros/3 tracks | 210 cm |
| DIY10.32.01.250 | 3 soros/3 tracks | 250 cm |
| DIY10.32.01.300 | 3 soros/3 tracks | 300 cm |



| VILÁGOS TÖLGY/OAK LIGHT | | |
|-------------------------|------------------|--------|
| DIY10.12.16.120 | 1 soros/1 track | 120 cm |
| DIY10.12.16.150 | 1 soros/1 track | 150 cm |
| DIY10.12.16.180 | 1 soros/1 track | 180 cm |
| DIY10.12.16.210 | 1 soros/1 track | 210 cm |
| DIY10.12.16.250 | 1 soros/1 track | 250 cm |
| DIY10.12.16.300 | 1 soros/1 track | 300 cm |
| DIY10.22.16.120 | 2 soros/2 tracks | 120 cm |
| DIY10.22.16.150 | 2 soros/2 tracks | 150 cm |
| DIY10.22.16.180 | 2 soros/2 tracks | 180 cm |
| DIY10.22.16.210 | 2 soros/2 tracks | 210 cm |
| DIY10.22.16.250 | 2 soros/2 tracks | 250 cm |
| DIY10.22.16.300 | 2 soros/2 tracks | 300 cm |
| DIY10.32.16.120 | 3 soros/3 tracks | 120 cm |
| DIY10.32.16.150 | 3 soros/3 tracks | 150 cm |
| DIY10.32.16.180 | 3 soros/3 tracks | 180 cm |
| DIY10.32.16.210 | 3 soros/3 tracks | 210 cm |
| DIY10.32.16.250 | 3 soros/3 tracks | 250 cm |
| DIY10.32.16.300 | 3 soros/3 tracks | 300 cm |



| RUSZTIKUS TÖLGY/OAK RUSTIC | | |
|----------------------------|------------------|--------|
| DIY10.12.18.120 | 1 soros/1 track | 120 cm |
| DIY10.12.18.150 | 1 soros/1 track | 150 cm |
| DIY10.12.18.180 | 1 soros/1 track | 180 cm |
| DIY10.12.18.210 | 1 soros/1 track | 210 cm |
| DIY10.12.18.250 | 1 soros/1 track | 250 cm |
| DIY10.12.18.300 | 1 soros/1 track | 300 cm |
| DIY10.22.18.120 | 2 soros/2 tracks | 120 cm |
| DIY10.22.18.150 | 2 soros/2 tracks | 150 cm |
| DIY10.22.18.180 | 2 soros/2 tracks | 180 cm |
| DIY10.22.18.210 | 2 soros/2 tracks | 210 cm |
| DIY10.22.18.250 | 2 soros/2 tracks | 250 cm |
| DIY10.22.18.300 | 2 soros/2 tracks | 300 cm |
| DIY10.32.18.120 | 3 soros/3 tracks | 120 cm |
| DIY10.32.18.150 | 3 soros/3 tracks | 150 cm |
| DIY10.32.18.180 | 3 soros/3 tracks | 180 cm |
| DIY10.32.18.210 | 3 soros/3 tracks | 210 cm |
| DIY10.32.18.250 | 3 soros/3 tracks | 250 cm |
| DIY10.32.18.300 | 3 soros/3 tracks | 300 cm |



| FEKETE/BLACK | | |
|-----------------|------------------|--------|
| DIY10.12.21.120 | 1 soros/1 track | 120 cm |
| DIY10.12.21.150 | 1 soros/1 track | 150 cm |
| DIY10.12.21.180 | 1 soros/1 track | 180 cm |
| DIY10.12.21.210 | 1 soros/1 track | 210 cm |
| DIY10.12.21.250 | 1 soros/1 track | 250 cm |
| DIY10.12.21.300 | 1 soros/1 track | 300 cm |
| DIY10.22.21.120 | 2 soros/2 tracks | 120 cm |
| DIY10.22.21.150 | 2 soros/2 tracks | 150 cm |
| DIY10.22.21.180 | 2 soros/2 tracks | 180 cm |
| DIY10.22.21.210 | 2 soros/2 tracks | 210 cm |
| DIY10.22.21.250 | 2 soros/2 tracks | 250 cm |
| DIY10.22.21.300 | 2 soros/2 tracks | 300 cm |



| DIÓ/WALNUT | | |
|-----------------|------------------|--------|
| DIY10.12.19.120 | 1 soros/1 track | 120 cm |
| DIY10.12.19.150 | 1 soros/1 track | 150 cm |
| DIY10.12.19.180 | 1 soros/1 track | 180 cm |
| DIY10.12.19.210 | 1 soros/1 track | 210 cm |
| DIY10.12.19.250 | 1 soros/1 track | 250 cm |
| DIY10.12.19.300 | 1 soros/1 track | 300 cm |
| DIY10.22.19.120 | 2 soros/2 tracks | 120 cm |
| DIY10.22.19.150 | 2 soros/2 tracks | 150 cm |
| DIY10.22.19.180 | 2 soros/2 tracks | 180 cm |
| DIY10.22.19.210 | 2 soros/2 tracks | 210 cm |
| DIY10.22.19.250 | 2 soros/2 tracks | 250 cm |
| DIY10.22.19.300 | 2 soros/2 tracks | 300 cm |
| DIY10.32.19.120 | 3 soros/3 tracks | 120 cm |
| DIY10.32.19.150 | 3 soros/3 tracks | 150 cm |
| DIY10.32.19.180 | 3 soros/3 tracks | 180 cm |
| DIY10.32.19.210 | 3 soros/3 tracks | 210 cm |
| DIY10.32.19.250 | 3 soros/3 tracks | 250 cm |
| DIY10.32.19.300 | 3 soros/3 tracks | 300 cm |



| NATÚR/NATUR | | |
|-----------------|------------------|--------|
| DIY10.12.17.120 | 1 soros/1 track | 120 cm |
| DIY10.12.17.150 | 1 soros/1 track | 150 cm |
| DIY10.12.17.180 | 1 soros/1 track | 180 cm |
| DIY10.12.17.210 | 1 soros/1 track | 210 cm |
| DIY10.12.17.250 | 1 soros/1 track | 250 cm |
| DIY10.12.17.300 | 1 soros/1 track | 300 cm |
| DIY10.22.17.120 | 2 soros/2 tracks | 120 cm |
| DIY10.22.17.150 | 2 soros/2 tracks | 150 cm |
| DIY10.22.17.180 | 2 soros/2 tracks | 180 cm |
| DIY10.22.17.210 | 2 soros/2 tracks | 210 cm |
| DIY10.22.17.250 | 2 soros/2 tracks | 250 cm |
| DIY10.22.17.300 | 2 soros/2 tracks | 300 cm |
| DIY10.32.17.120 | 3 soros/3 tracks | 120 cm |
| DIY10.32.17.150 | 3 soros/3 tracks | 150 cm |
| DIY10.32.17.180 | 3 soros/3 tracks | 180 cm |
| DIY10.32.17.210 | 3 soros/3 tracks | 210 cm |
| DIY10.32.17.250 | 3 soros/3 tracks | 250 cm |
| DIY10.32.17.300 | 3 soros/3 tracks | 300 cm |



| BÜKK/BEECH | | |
|-----------------|------------------|--------|
| DIY10.12.73.120 | 1 soros/1 track | 120 cm |
| DIY10.12.73.150 | 1 soros/1 track | 150 cm |
| DIY10.12.73.180 | 1 soros/1 track | 180 cm |
| DIY10.12.73.210 | 1 soros/1 track | 210 cm |
| DIY10.12.73.250 | 1 soros/1 track | 250 cm |
| DIY10.12.73.300 | 1 soros/1 track | 300 cm |
| DIY10.22.73.120 | 2 soros/2 tracks | 120 cm |
| DIY10.22.73.150 | 2 soros/2 tracks | 150 cm |
| DIY10.22.73.180 | 2 soros/2 tracks | 180 cm |
| DIY10.22.73.210 | 2 soros/2 tracks | 210 cm |
| DIY10.22.73.250 | 2 soros/2 tracks | 250 cm |
| DIY10.22.73.300 | 2 soros/2 tracks | 300 cm |
| DIY10.32.73.120 | 3 soros/3 tracks | 120 cm |
| DIY10.32.73.150 | 3 soros/3 tracks | 150 cm |
| DIY10.32.73.180 | 3 soros/3 tracks | 180 cm |
| DIY10.32.73.210 | 3 soros/3 tracks | 210 cm |
| DIY10.32.73.250 | 3 soros/3 tracks | 250 cm |
| DIY10.32.73.300 | 3 soros/3 tracks | 300 cm |



| SZONOMA/SONOMA | | |
|-----------------|------------------|--------|
| DIY10.12.80.120 | 1 soros/1 track | 120 cm |
| DIY10.12.80.150 | 1 soros/1 track | 150 cm |
| DIY10.12.80.180 | 1 soros/1 track | 180 cm |
| DIY10.12.80.210 | 1 soros/1 track | 210 cm |
| DIY10.12.80.250 | 1 soros/1 track | 250 cm |
| DIY10.12.80.300 | 1 soros/1 track | 300 cm |
| DIY10.22.80.120 | 2 soros/2 tracks | 120 cm |
| DIY10.22.80.150 | 2 soros/2 tracks | 150 cm |
| DIY10.22.80.180 | 2 soros/2 tracks | 180 cm |
| DIY10.22.80.210 | 2 soros/2 tracks | 210 cm |
| DIY10.22.80.250 | 2 soros/2 tracks | 250 cm |
| DIY10.22.80.300 | 2 soros/2 tracks | 300 cm |
| DIY10.32.80.120 | 3 soros/3 tracks | 120 cm |
| DIY10.32.80.150 | 3 soros/3 tracks | 150 cm |
| DIY10.32.80.180 | 3 soros/3 tracks | 180 cm |
| DIY10.32.80.210 | 3 soros/3 tracks | 210 cm |
| DIY10.32.80.250 | 3 soros/3 tracks | 250 cm |
| DIY10.32.80.300 | 3 soros/3 tracks | 300 cm |

Ívek/Arch

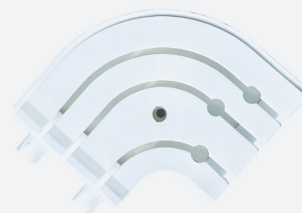

| 1 SOROS SÍNHEZ/ 1 TRACK | | |
|-------------------------|-------------------------------------|----------|
| DIY10.11.01-2 | Lezáróív/ closing arc | 2 db/pcs |
| DIY10.12.01-1 | Belsőíves összekötőív/ inner arc | 1 db/pcs |
| DIY10.13.01-1 | Külsőíves összekötőív/ outer arc | 1 db/pcs |
| DIY10.11.21-2 | Lezáróív/ closing arc | 2 db/pcs |
| DIY10.12.21-1 | Belsőíves összekötőív/ inner arc | 1 db/pcs |
| DIY10.13.21-1 | Külsőíves összekötőív/ outer arc | 1 db/pcs |

| 2 SOROS SÍNHEZ/ 2 TRACKS | | |
|--------------------------|-------------------------------------|----------|
| DIY10.21.01-2 | Lezáróív/ closing arc | 2 db/pcs |
| DIY10.22.01-1 | Belsőíves összekötőív/ inner arc | 1 db/pcs |
| DIY10.23.01-1 | Külsőíves összekötőív/ outer arc | 1 db/pcs |
| DIY10.21.21-2 | Lezáróív/ closing arc | 2 db/pcs |
| DIY10.22.21-1 | Belsőíves összekötőív/ inner arc | 1 db/pcs |
| DIY10.23.21-1 | Külsőíves összekötőív/ outer arc | 1 db/pcs |

| 3 SOROS SÍNHEZ/ 3 TRACKS | | |
|--------------------------|-------------------------------------|----------|
| DIY10.31.01-2 | Lezáróív/ closing arc | 2 db/pcs |
| DIY10.32.01-1 | Belsőíves összekötőív/ inner arc | 1 db/pcs |
| DIY10.33.01-1 | Külsőíves összekötőív/ outer arc | 1 db/pcs |

Előlapok (50/75 mm)/pelmets

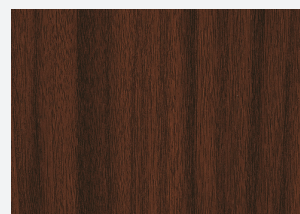
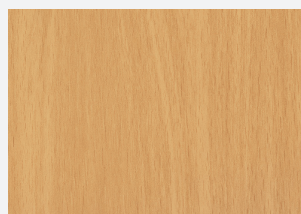
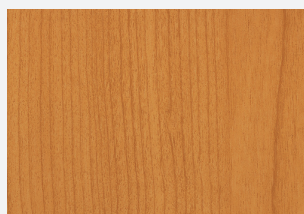
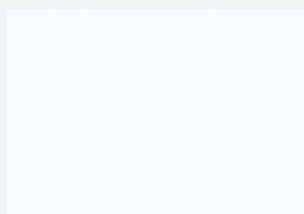

| FEHÉR/WHITE | | |
|---------------|-------|-----|
| 10.90.01.2500 | 50 mm | 1 m |
| 10.97.01.2500 | 75 mm | 1 m |

| VILÁGOS TÖLGY/OAK LIGHT | | |
|-------------------------|-------|-----|
| 10.90.16.2500 | 50 mm | 1 m |

| NATÚR/NATUR | | |
|---------------|-------|-----|
| 10.90.17.2500 | 50 mm | 1 m |

| DIÓ/WALNUT | | |
|---------------|-------|-----|
| 10.90.19.2500 | 50 mm | 1 m |

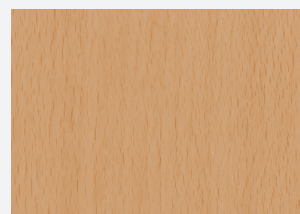
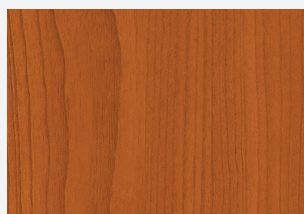
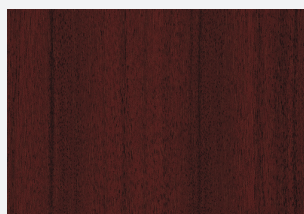

| MAHAGÓNI/MAHOGANY | | |
|-------------------|-------|-----|
| 10.90.20.2500 | 50 mm | 1 m |

| CSERESZNYE/CHERRY-TREE | | |
|------------------------|-------|-----|
| 10.90.22.2500 | 50 mm | 1 m |

| TEAK | | |
|---------------|-------|-----|
| 10.90.60.2500 | 50 mm | 1 m |

| BÜKK/BEECH | | |
|---------------|-------|-----|
| 10.90.73.2500 | 50 mm | 1 m |

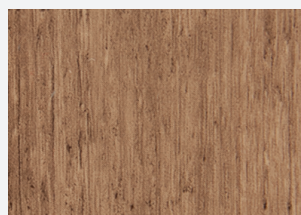
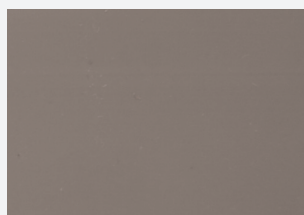
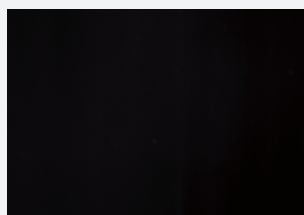

| FEKETE/BLACK | | |
|---------------|-------|-----|
| 10.90.21.2500 | 50 mm | 1 m |
| 10.97.21.2500 | 75 mm | 1 m |

| MATT-KRÓM/MATT-CHROME | | |
|-----------------------|-------|-----|
| 10.90.39.2500 | 50 mm | 1 m |

| SZONOMA/SONOMA | | |
|----------------|-------|-----|
| 10.90.80.2500 | 50 mm | 1 m |

**VÉGZÁRÓ (FEHÉR/FEKETE)
SIDE COVER (WHITE/BLACK)**

| | | | |
|---------------|------------------|----------|--|
| DIY10.14.01-2 | 1 soros/1 track | 2 db/pcs | |
| DIY10.24.01-2 | 2 soros/2 tracks | 2 db/pcs | |
| DIY10.34.01-2 | 3 soros/3 tracks | 2 db/pcs | |
| DIY10.14.21-2 | 1 soros/1 track | 2 db/pcs | |
| DIY10.24.21-2 | 2 soros/2 tracks | 2 db/pcs | |

**TOLDÓ (FEHÉR/FEKETE)
CONNECTOR (WHITE/BLACK)**

| | | | |
|---------------|--------------|----------|--|
| DIY10.40.01-2 | fehér/white | 2 db/pcs | |
| DIY10.40.21-2 | fekete/black | 2 db/pcs | |

**GÖRGŐ RÁNCSEDŐVEL (FEHÉR/FEKETE)
RUNNER WITH HOOK (WHITE/BLACK)**

| | | |
|-----------------|------------|--|
| DIY108418-20 | 20 db/pcs | |
| DIY108418-50 | 50 db/pcs | |
| DIY108418-100 | 100 db/pcs | |
| DIY108418.21-20 | 20 db/pcs | |

**GÖRGŐKOCSI RÁNCSEDŐVEL
(FEHÉR/FEKETE)
FLINGING WAGENK
(WHITE/BLACK)**

| | | |
|----------------|----------|--|
| DIY101038-4 | 4 db/pcs | |
| DIY101038.21-4 | 4 db/pcs | |

**SZÖGLETES LEZÁRÓ (FEHÉR/FEKETE)
ENDING (WHITE/BLACK)**

| | | | |
|----------------|----------|----------|--|
| DIY104015-6 | 10x12 mm | 6 db/pcs | |
| DIY104015.21-6 | 10x12 mm | 6 db/pcs | |

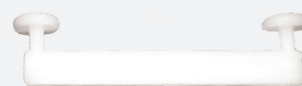
**FÜLESFÜGGÖNY CSÚSZKA (FEHÉR/FEKETE)
LOOP GLIDER (WHITE/BLACK)**

| | | | |
|-----------------|-------|-----------|--|
| DIY108420-10 | 50 mm | 10 db/pcs | |
| DIY108420.21-10 | 50 mm | 10 db/pcs | |

**FURATTAKARÓ GOMB (FEHÉR/FEKETE)
COVERING BUTTON (WHITE/BLACK)**

| | | | |
|-----------------|------|-----------|--|
| DIY104011-20 | 9 mm | 20 db/pcs | |
| DIY104011.21-20 | 9 mm | 20 db/pcs | |

**TAROZÉKCSOMAG 1 SOROS SÍNHEZ
(FEHÉR/FEKETE)
ACCESSORY BAG (WHITE/BLACK)**

| | | |
|--------------------|------------|--|
| DIY10.10.120180 | 120-180 cm | |
| DIY10.10.210300 | 210-300 cm | |
| DIY10.10.300400 | 300-400 cm | |
| DIY10.10.21.210300 | 210-300 cm | |
| DIY10.10.21.300400 | 300-400 cm | |

**TAROZÉKCSOMAG 2-3 SOROS SÍNHEZ
(FEHÉR/FEKETE)
ACCESSORY BAG (WHITE/BLACK)**

| | | |
|--------------------|------------|--|
| DIY10.20.120180 | 120-180 cm | |
| DIY10.20.210300 | 210-300 cm | |
| DIY10.20.300400 | 300-400 cm | |
| DIY10.20.21.210300 | 210-300 cm | |
| DIY10.20.21.300400 | 300-400 cm | |

**GÖRGŐ CSIPESSZEL (FEHÉR/FEKETE)
RUNNER WITH CLIP (WHITE/BLACK)**

| | | |
|-----------------|-----------|--|
| DIY104021-10 | 10 db/pcs | |
| DIY104021-20 | 20 db/pcs | |
| DIY104021.21-20 | 20 db/pcs | |

KÖZBENSŐ LEZÁRÓ/ENDING

| | | |
|-------------|-----------|----------|
| DIY104016-6 | universal | 6 db/pcs |
|-------------|-----------|----------|

GÖRGŐPÁLYA LEZÁRÓ/ENDING

| | |
|-------------|----------|
| DIY104026-6 | 6 db/pcs |
|-------------|----------|

FÜGGÖNYHOROG/CURTAIN HOOK

| | |
|---------------|------------|
| DIY609031-10 | 10 db/pcs |
| DIY609031-100 | 100 db/pcs |

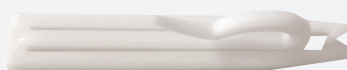
RÁNCOLÓKAMPÓ/PLEAT HOOK

| | |
|--------------|-----------|
| DIY609032-20 | 20 db/pcs |
|--------------|-----------|

**CSÚSZKA RÁNCSEDŐVEL (KEREK FEJŰ)/
GLIDER WITH HOOK (ROUND HEAD)**

| | |
|--------------|-----------|
| DIY104008-20 | 20 db/pcs |
| DIY104008-50 | 50 db/pcs |

**CSÚSZKA RÁNCSEDŐVEL (SZÖGLETES FEJŰ)/
GLIDER WITH HOOK SQUARE HEAD**

| | |
|--------------|-----------|
| DIY104007-20 | 20 db/pcs |
| DIY104007-50 | 50 db/pcs |

CSÚSZKA/GLIDER

| | |
|--------------|-----------|
| DIY205000-20 | 20 db/pcs |
| DIY205000-50 | 50 db/pcs |

FÜGGÖNGÖRGŐ/T-ROLLER

| | | |
|--------------|-------------|-----------|
| DIY205002-20 | fém/műanyag | 20 db/pcs |
| DIY205002-50 | fém/műanyag | 50 db/pcs |

**OLDALFALI TARTÓ (FÉM, MŰA. HÍDDAL)/
ANGLE BRACKET**

| | | |
|--------------|--------|----------|
| DIY104028-2 | rövid | 2 db/pcs |
| DIY104028H-2 | hosszú | 2 db/pcs |

**Alumínium
mennyezeti
profilok
és tartozékaik**

**Aluminium
ceiling tracks
& accessories**



Alumínium mennyezeti profil 1 soros
Aluminium 1 track ceiling track

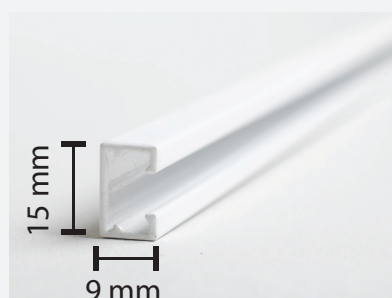

| ALUMÍNÍUM MENNYEZETI PROFIL 1 SOROS/ ALUMINIUM 1 TRACK CEILING TRACK | | |
|---|-------------------------------|--------|
| DIY10.81.01.120 | 1 soros/1 track - fehér/white | 120 cm |
| DIY10.81.01.160 | 1 soros/1 track - fehér/white | 160 cm |
| DIY10.81.01.200 | 1 soros/1 track - fehér/white | 200 cm |
| DIY10.81.01.240 | 1 soros/1 track - fehér/white | 240 cm |
| DIY10.81.01.300 | 1 soros/1 track - fehér/white | 300 cm |
| DIY10.81.01.360 | 1 soros/1 track - fehér/white | 360 cm |
| DIY10.81.01.400 | 1 soros/1 track - fehér/white | 400 cm |

Alumínium mennyezeti profil 2 soros
Aluminium 2 track ceiling track

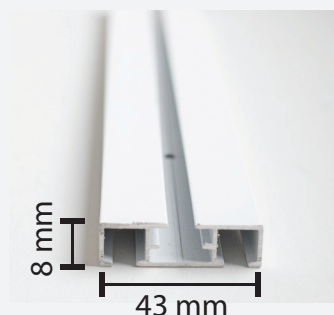

| ALUMÍNÍUM MENNYEZETI PROFIL 2 SOROS/ ALUMINIUM 2 TRACK CEILING TRACK | | |
|---|-------------------------------|--------|
| DIY10.82.01.120 | 2 soros/2 track - fehér/white | 120 cm |
| DIY10.82.01.160 | 2 soros/2 track - fehér/white | 160 cm |
| DIY10.82.01.200 | 2 soros/2 track - fehér/white | 200 cm |
| DIY10.82.01.240 | 2 soros/2 track - fehér/white | 240 cm |
| DIY10.82.01.300 | 2 soros/2 track - fehér/white | 300 cm |
| DIY10.82.01.360 | 2 soros/2 track - fehér/white | 360 cm |
| DIY10.82.01.400 | 2 soros/2 track - fehér/white | 400 cm |

Alumínium mennyezeti profil 3 soros
Aluminium 3 track ceiling track

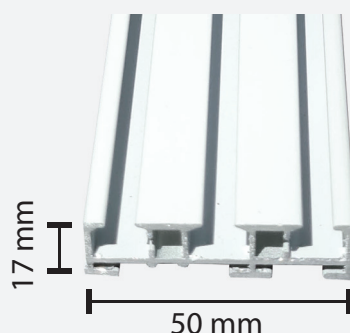

| ALUMÍNÍUM MENNYEZETI PROFIL 3 SOROS/ ALUMINIUM 3 TRACK CEILING TRACK | | |
|---|-------------------------------|--------|
| DIY10.83.01.120 | 3 soros/3 track - fehér/white | 120 cm |
| DIY10.83.01.160 | 3 soros/3 track - fehér/white | 160 cm |
| DIY10.83.01.200 | 3 soros/3 track - fehér/white | 200 cm |
| DIY10.83.01.240 | 3 soros/3 track - fehér/white | 240 cm |
| DIY10.83.01.300 | 3 soros/3 track - fehér/white | 300 cm |
| DIY10.83.01.360 | 3 soros/3 track - fehér/white | 360 cm |
| DIY10.83.01.400 | 3 soros/3 track - fehér/white | 400 cm |

Előlapos aluprofil 2 soros
Front panel aluminium profile 2 track

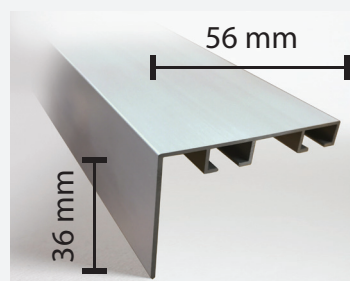
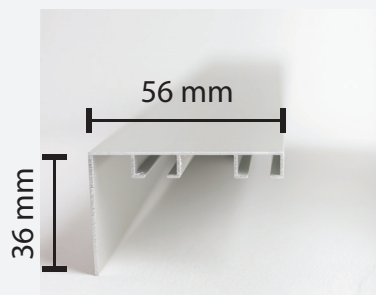

| ELŐLAPOS ALUPROFIL 2 SOROS/ FRONT PANEL ALUMINIUM PROFILE 2 TRACK | |
|--|-------------------------------|
| DIY10.92.01.120 | 2-soros, 120 cm - fehér/white |
| DIY10.92.01.160 | 2-soros, 160 cm - fehér/white |
| DIY10.92.01.200 | 2-soros, 200 cm - fehér/white |
| DIY10.92.01.240 | 2-soros, 240 cm - fehér/white |
| DIY10.92.01.300 | 2-soros, 300 cm - fehér/white |
| DIY10.92.01.360 | 2-soros, 360 cm - fehér/white |
| DIY10.92.01.400 | 2-soros, 400 cm - fehér/white |

| ELŐLAPOS ALUPROFIL 2 SOROS/ FRONT PANEL ALUMINIUM PROFILE 2 TRACK | |
|--|--|
| DIY10.92.39.120 | 2-soros, 120 cm, matt-króm/matt-chrome |
| DIY10.92.39.160 | 2-soros, 160 cm, matt-króm/matt-chrome |
| DIY10.92.39.200 | 2-soros, 200 cm, matt-króm/matt-chrome |
| DIY10.92.39.240 | 2-soros, 240 cm, matt-króm/matt-chrome |
| DIY10.92.39.300 | 2-soros, 300 cm, matt-króm/matt-chrome |
| DIY10.92.39.360 | 2-soros, 360 cm, matt-króm/matt-chrome |
| DIY10.92.39.400 | 2-soros, 400 cm, matt-króm/matt-chrome |



| 2 SOROS ELŐLAPOS VÉGZÁRÓ ALU PROFILHOZ/ 2 TRACK FRONT PANEL PROFILE END | | |
|--|---|----------|
| DIY10.92.04.01-2 | 2 soros végzáró/ 2 track end, fehér/white | 2 db/pcs |
| DIY10.92.04.39-2 | 2 soros végzáró/ 2 track end, matt-króm/matt-chrome | 2 db/pcs |

| ALUMÍNÍUM SÍN OLDALFALI TARTÓ 2 ÉS 3 SOROS PROFILHOZ/ ALUMINIUM SIDE RAILS WALL MOUNT FOR 2 & 3 TRACK PROFILE END | | |
|--|------------------------------|----------|
| DIY108208.39-1 | 8 cm, matt-króm/matt-chrome | 1 db/pcs |
| DIY108212.39-1 | 12 cm, matt-króm/matt-chrome | 1 db/pcs |
| DIY108208.01-1 | 8 cm, fehér/white | 1 db/pcs |
| DIY108212.01-1 | 12 cm, fehér/white | 1 db/pcs |



T-csúszka



X-csúszka

| TARTOZÉKCSOMAGOK 1 SOROS PROFILHOZ/ ACCESSORY BAG FOR 1 TRACK PROFILE | | | TARTOZÉKCSOMAGOK 2 SOROS PROFILHOZ/ ACCESSORY BAG FOR 2 TRACK PROFILE | | |
|--|--------------------------------|-----------------------------|--|--------------------------------|-----------------------------|
| DIY10.81.120.T | 1 soros 120 cm/ 1 track 120 cm | T-csúszkával/ with T-glider | DIY10.82.120.T | 2 soros 120 cm/ 2 track 120 cm | T-csúszkával/ with T-glider |
| DIY10.81.120.X | 1 soros 120 cm/ 1 track 120 cm | X-csúszkával/ with X-glider | DIY10.82.120.X | 2 soros 120 cm/ 2 track 120 cm | X-csúszkával/ with X-glider |
| DIY10.81.160.T | 1 soros 160 cm/ 1 track 160 cm | T-csúszkával/ with T-glider | DIY10.82.160.T | 2 soros 160 cm/ 2 track 160 cm | T-csúszkával/ with T-glider |
| DIY10.81.160.X | 1 soros 160 cm/ 1 track 160 cm | X-csúszkával/ with X-glider | DIY10.82.160.X | 2 soros 160 cm/ 2 track 160 cm | X-csúszkával/ with X-glider |
| DIY10.81.200.T | 1 soros 200 cm/ 1 track 200 cm | T-csúszkával/ with T-glider | DIY10.82.200.T | 2 soros 200 cm/ 2 track 200 cm | T-csúszkával/ with T-glider |
| DIY10.81.200.X | 1 soros 200 cm/ 1 track 200 cm | X-csúszkával/ with X-glider | DIY10.82.200.X | 2 soros 200 cm/ 2 track 200 cm | X-csúszkával/ with X-glider |
| DIY10.81.240.T | 1 soros 240 cm/ 1 track 240 cm | T-csúszkával/ with T-glider | DIY10.82.240.T | 2 soros 240 cm/ 2 track 240 cm | T-csúszkával/ with T-glider |
| DIY10.81.240.X | 1 soros 240 cm/ 1 track 240 cm | X-csúszkával/ with X-glider | DIY10.82.240.X | 2 soros 240 cm/ 2 track 240 cm | X-csúszkával/ with X-glider |
| DIY10.81.300.T | 1 soros 300 cm/ 1 track 300 cm | T-csúszkával/ with T-glider | DIY10.82.300.T | 2 soros 300 cm/ 2 track 300 cm | T-csúszkával/ with T-glider |
| DIY10.81.300.X | 1 soros 300 cm/ 1 track 300 cm | X-csúszkával/ with X-glider | DIY10.82.300.X | 2 soros 300 cm/ 2 track 300 cm | X-csúszkával/ with X-glider |
| DIY10.81.360.T | 1 soros 360 cm/ 1 track 360 cm | T-csúszkával/ with T-glider | DIY10.82.360.T | 2 soros 360 cm/ 2 track 360 cm | T-csúszkával/ with T-glider |
| DIY10.81.360.X | 1 soros 360 cm/ 1 track 360 cm | X-csúszkával/ with X-glider | DIY10.82.360.X | 2 soros 360 cm/ 2 track 360 cm | X-csúszkával/ with X-glider |
| DIY10.81.400.T | 1 soros 400 cm/ 1 track 400 cm | T-csúszkával/ with T-glider | DIY10.82.400.T | 2 soros 400 cm/ 2 track 400 cm | T-csúszkával/ with T-glider |
| DIY10.81.400.X | 1 soros 400 cm/ 1 track 400 cm | X-csúszkával/ with X-glider | DIY10.82.400.X | 2 soros 400 cm/ 2 track 400 cm | X-csúszkával/ with X-glider |



1 SOROS VÉGZÁRÓ ALU PROFILHOZ/ 1 TRACK PROFILE END

| | | |
|------------------|------------------------------|----------|
| DIY10.81.04.01-2 | 1 soros végzáró/ 1 track end | 2 db/pcs |
|------------------|------------------------------|----------|



2 SOROS VÉGZÁRÓ ALU PROFILHOZ/ 2 TRACK PROFILE END

| | | |
|------------------|------------------------------|----------|
| DIY10.82.04.01-2 | 2 soros végzáró/ 2 track end | 2 db/pcs |
|------------------|------------------------------|----------|

| TARTOZÉKCSOMAGOK 3 SOROS PROFILHOZ/ ACCESSORY BAG FOR 3 TRACK PROFILE | | |
|--|--------------------------------|-----------------------------|
| DIY10.83.120.T | 3 soros 120 cm/ 3 track 120 cm | T-csúszkával/ with T-glider |
| DIY10.83.120.X | 3 soros 120 cm/ 3 track 120 cm | X-csúszkával/ with X-glider |
| DIY10.83.160.T | 3 soros 160 cm/ 3 track 160 cm | T-csúszkával/ with T-glider |
| DIY10.83.160.X | 3 soros 160 cm/ 3 track 160 cm | X-csúszkával/ with X-glider |
| DIY10.83.200.T | 3 soros 200 cm/ 3 track 200 cm | T-csúszkával/ with T-glider |
| DIY10.83.200.X | 3 soros 200 cm/ 3 track 200 cm | X-csúszkával/ with X-glider |
| DIY10.83.240.T | 3 soros 240 cm/ 3 track 240 cm | T-csúszkával/ with T-glider |
| DIY10.83.240.X | 3 soros 240 cm/ 3 track 240 cm | X-csúszkával/ with X-glider |
| DIY10.83.300.T | 3 soros 300 cm/ 3 track 300 cm | T-csúszkával/ with T-glider |
| DIY10.83.300.X | 3 soros 300 cm/ 3 track 300 cm | X-csúszkával/ with X-glider |
| DIY10.83.360.T | 3 soros 360 cm/ 3 track 360 cm | T-csúszkával/ with T-glider |
| DIY10.83.360.X | 3 soros 360 cm/ 3 track 360 cm | X-csúszkával/ with X-glider |
| DIY10.83.400.T | 3 soros 400 cm/ 3 track 400 cm | T-csúszkával/ with T-glider |
| DIY10.83.400.X | 3 soros 400 cm/ 3 track 400 cm | X-csúszkával/ with X-glider |

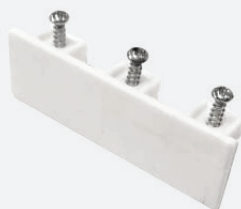

3 SOROS VÉGZÁRÓ ALU PROFILHOZ/ 3 TRACK PROFILE END

| | | |
|------------------|------------------------------|----------|
| DIY10.83.04.01-2 | 3 soros végzáró/ 3 track end | 2 db/pcs |
|------------------|------------------------------|----------|



**ALUMÍNÍUM SÍN MENNYEZETI TARTÓ/
ALUMINIUM CEILING BRACKET**

| | | |
|----------------|--------------------------------|----------|
| DIY108399.01-1 | Alumínium sín mennyezeti tartó | 1 db/pcs |
|----------------|--------------------------------|----------|



Kiegészítők Accessories



Függönyelhúzó pálc
Curtain Flinging Rod



| FEHÉR/WHITE | | |
|-----------------|--------|----------|
| DIY11.91.01.050 | 50 cm | 1 db/pcs |
| DIY11.91.01.075 | 75 cm | 1 db/pcs |
| DIY11.91.01.100 | 100 cm | 1 db/pcs |
| DIY11.91.01.125 | 125 cm | 1 db/pcs |
| DIY11.91.01.150 | 150 cm | 1 db/pcs |

| KRÓM/CHROME | | |
|-----------------|--------|----------|
| DIY11.91.14.050 | 50 cm | 1 db/pcs |
| DIY11.91.14.075 | 75 cm | 1 db/pcs |
| DIY11.91.14.100 | 100 cm | 1 db/pcs |
| DIY11.91.14.125 | 125 cm | 1 db/pcs |
| DIY11.91.14.150 | 150 cm | 1 db/pcs |

fém és műanyag alkatrészekkel (metal with plastic accessories)

| NATÚR/NATUR | | |
|-----------------|--------|----------|
| SB 11.92.17.050 | 50 cm | 1 db/pcs |
| SB 11.92.17.075 | 75 cm | 1 db/pcs |
| SB 11.92.17.100 | 100 cm | 1 db/pcs |
| SB 11.92.17.125 | 125 cm | 1 db/pcs |

| RUSZTIKUS TÖLGY/RUSTIC OAK | | |
|----------------------------|--------|----------|
| SB 11.92.18.050 | 50 cm | 1 db/pcs |
| SB 11.92.18.075 | 75 cm | 1 db/pcs |
| SB 11.92.18.100 | 100 cm | 1 db/pcs |
| SB 11.92.18.125 | 125 cm | 1 db/pcs |

fém és fa alkatrészekkel (metal with plastic accessories)

Dekorcsipeszek/Deco clips



| LEVÉL/LEAF | | | |
|----------------|-----------------------|----------|--|
| DIY458020.01-2 | fehér/white | 2 db/pcs | |
| DIY458020.03-2 | beige | 2 db/pcs | |
| DIY458020.05-2 | terrakotta/terracotta | 2 db/pcs | |
| DIY458020.13-2 | rezezt/brass | 2 db/pcs | |
| DIY458020.14-2 | krómozott/chrome | 2 db/pcs | |

| CSILLAG/STAR | | | |
|----------------|-----------------------|----------|--|
| DIY458019.01-2 | fehér/white | 2 db/pcs | |
| DIY458019.03-2 | beige | 2 db/pcs | |
| DIY458019.05-2 | terrakotta/terracotta | 2 db/pcs | |
| DIY458019.13-2 | rezezt/brass | 2 db/pcs | |
| DIY458019.14-2 | krómozott/chrome | 2 db/pcs | |

| LILIOM/LILIE | | | |
|----------------|----------|--|--|
| DIY458021.01-2 | 2 db/pcs | | |



| HOLD/MOON | | | |
|----------------|-----------------------|----------|--|
| DIY458022.01-2 | fehér/white | 2 db/pcs | |
| DIY458022.03-2 | beige | 2 db/pcs | |
| DIY458022.05-2 | terrakotta/terracotta | 2 db/pcs | |
| DIY458022.13-2 | rezezt/brass | 2 db/pcs | |
| DIY458022.14-2 | krómozott/chrome | 2 db/pcs | |

| NAP/SUN | | | |
|----------------|-----------------------|----------|--|
| DIY458017.01-2 | fehér/white | 2 db/pcs | |
| DIY458017.03-2 | beige | 2 db/pcs | |
| DIY458017.05-2 | terrakotta/terracotta | 2 db/pcs | |
| DIY458017.13-2 | rezezt/brass | 2 db/pcs | |
| DIY458017.14-2 | krómozott/chrome | 2 db/pcs | |

Fémcsipeszek/Metal clips

**KLASSZIKUS FÜGGÖNYCSIPESZ/
CURTAIN CLIP**

| | | | |
|-----------------|---------------------------|-----------|--|
| DIY458011.01-20 | fehér/white | 20 db/pcs | |
| DIY458011.02-20 | bronz/bronze | 20 db/pcs | |
| DIY458011.03-20 | beige | 20 db/pcs | |
| DIY458011.13-20 | rezezett/brass | 20 db/pcs | |
| DIY458011.14-20 | krómozott/ chrome | 20 db/pcs | |
| DIY458011.05-20 | terracotta/ terracotta | 20 db/pcs | |
| DIY458011.62-20 | óarany/ antique gold | 20 db/pcs | |
| DIY458011.21-20 | fekete/black | 20 db/pcs | |

KARNISCSIPESZ/CORNICE CLIP

| | | | |
|-----------------|---------------------------|-----------|--|
| DIY458012.01-10 | fehér/white | 10 db/pcs | |
| DIY458012.02-10 | bronz/bronze | 10 db/pcs | |
| DIY458012.03-10 | beige | 10 db/pcs | |
| DIY458012.13-10 | rezezett/brass | 10 db/pcs | |
| DIY458012.14-10 | krómozott/ chrome | 10 db/pcs | |
| DIY458012.05-10 | terracotta/ terracotta | 10 db/pcs | |
| DIY458012.21-10 | fekete/black | 10 db/pcs | |

**MODERN FÜGGÖNYCSIPESZ/
CURTAIN CLIP MODERN**

| | | | |
|-----------------|----------------------|-----------|--|
| DIY458010.14-20 | krómozott/ chrome | 20 db/pcs | |
|-----------------|----------------------|-----------|--|

VITRAGECSIPESZ/VITRAGE CLIP

| | | | |
|-----------------|----------------------|-----------|--|
| DIY458013.01-20 | fehér/white | 20 db/pcs | |
| DIY458013.02-20 | bronz/bronze | 20 db/pcs | |
| DIY458013.03-20 | beige | 20 db/pcs | |
| DIY458013.13-20 | rezezett/brass | 20 db/pcs | |
| DIY458013.14-20 | krómozott/ chrome | 20 db/pcs | |

**KARIKACCSIPESZ 30 MM/
DECO-CLIP 30MM**

| | | | |
|-----------------|----------------------|-----------|--|
| DIY458030.01-10 | fehér/white | 10 db/pcs | |
| DIY458030.02-10 | bronz/bronze | 10 db/pcs | |
| DIY458030.03-10 | beige | 10 db/pcs | |
| DIY458030.13-10 | rezezett/brass | 10 db/pcs | |
| DIY458030.14-10 | krómozott/ chrome | 10 db/pcs | |
| DIY458030.21-10 | fekete/black | 10 db/pcs | |

**KARIKACCSIPESZ 40 MM/
DECO-CLIP 40MM**

| | | | |
|-----------------|----------------------|-----------|--|
| DIY458040.01-10 | fehér/white | 10 db/pcs | |
| DIY458040.02-10 | bronz/bronze | 10 db/pcs | |
| DIY458040.03-10 | beige | 10 db/pcs | |
| DIY458040.13-10 | rezezett/brass | 10 db/pcs | |
| DIY458040.14-10 | krómozott/ chrome | 10 db/pcs | |
| DIY458040.21-10 | fekete/black | 10 db/pcs | |

Függönyelkötők/Curtain tie backs



| MALACFAROK/TASSEL HOOK | | | |
|------------------------|--------------|----------|--|
| DIY451005.01-2 | fehér/white | 2 db/pcs | |
| DIY451005.13-2 | rezezt/brass | 2 db/pcs | |



| GÖMB KAMPÓ/TASSEL HOOK BALL | | | |
|-----------------------------|---------------------|----------|--|
| DIY850008.01-2 | fehér/white | 2 db/pcs | |
| DIY850008.14-2 | króm/chrome | 2 db/pcs | |
| DIY850008.21-2 | fekete/black | 2 db/pcs | |
| DIY850008.62-2 | óarany/antique gold | 2 db/pcs | |



| JERSEY | | | |
|----------------|-------------------------|----------|--|
| DIY451007.21-2 | fekete/black | 2 db/pcs | |
| DIY451007.40-2 | nikkel-matt/nickel-matt | 2 db/pcs | |
| DIY451007.62-2 | óarany/antique gold | 2 db/pcs | |



| KRISTÁLY KAMPÓ/TASSEL HOOK CRYSTAL | | | |
|------------------------------------|---------------------|----------|--|
| DIY850009.01-2 | fehér/white | 2 db/pcs | |
| DIY850009.14-2 | króm/chrome | 2 db/pcs | |
| DIY850009.21-2 | fekete/black | 2 db/pcs | |
| DIY850009.62-2 | óarany/antique gold | 2 db/pcs | |



| SAN DIEGO | | | |
|----------------|-------------------------|----------|--|
| DIY451008.40-2 | nikkel-matt/nickel-matt | 2 db/pcs | |
| DIY451008.62-2 | óarany/antique gold | 2 db/pcs | |



| ROZETTA KAMPÓ/TASSEL HOOK ROSETTA | | | |
|-----------------------------------|-------------|----------|--|
| DIY850101.01-2 | fehér/white | 2 db/pcs | |
| DIY850101.14-2 | króm/chrome | 2 db/pcs | |
| DIY850101.13-2 | réz/brass | 2 db/pcs | |

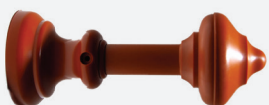

| FILIGRANO FÜGGÖNYKIKÖTŐ/TASSEL HOOK | | | |
|-------------------------------------|-----------------------|----------|--|
| DIY288090.01-1 | fehér/white | 1 db/pcs | |
| DIY288090.03-1 | bézs/beige | 1 db/pcs | |
| DIY288090.04-1 | barna/brown | 1 db/pcs | |
| DIY288090.05-1 | terrakotta/terracotta | 1 db/pcs | |



| CSILLAG KAMPÓ/TASSEL HOOK STAR | | | |
|--------------------------------|-------------|----------|--|
| DIY850010.01-2 | fehér/white | 2 db/pcs | |
| DIY850010.13-2 | réz/brass | 2 db/pcs | |
| DIY850010.14-2 | króm/chrome | 2 db/pcs | |

Statikus üvegfólia Static window foil





| KÖD/MIST | |
|--------------|-------------|
| DIY1601.45-1 | 45x150 cm |
| DIY1601.67-1 | 67,5x150 cm |
| DIY1601.90-1 | 90x150 cm |



| CSÍKOS/STRIPED | |
|----------------|-------------|
| DIY1623.45-1 | 45x150 cm |
| DIY1623.67-1 | 67,5x150 cm |
| DIY1623.90-1 | 90x150 cm |



| LEVÉL/LEAF | |
|--------------|-------------|
| DIY1633.45-1 | 45x150 cm |
| DIY1633.67-1 | 67,5x150 cm |
| DIY1633.90-1 | 90x150 cm |



| MOZAIK/MOSAIC | |
|---------------|-------------|
| DIY1630.45-1 | 45x150 cm |
| DIY1630.67-1 | 67,5x150 cm |
| DIY1630.90-1 | 90x150 cm |

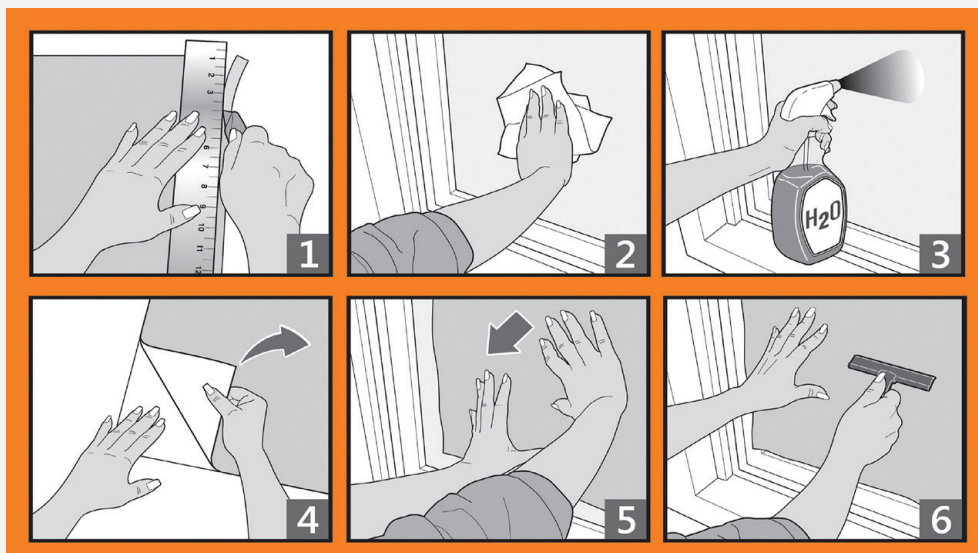

Rolók Rollo





FEHÉR / WHITE

| | |
|-----------------|------------|
| DIY17.81.01.060 | 60x150 cm |
| DIY17.81.01.070 | 70x150 cm |
| DIY17.81.01.080 | 80x150 cm |
| DIY17.81.01.090 | 90x150 cm |
| DIY17.81.01.100 | 100x150 cm |
| DIY17.81.01.120 | 120x150 cm |



BÉZS / BEIGE

| | |
|-----------------|------------|
| DIY17.81.03.060 | 60x150 cm |
| DIY17.81.03.070 | 70x150 cm |
| DIY17.81.03.080 | 80x150 cm |
| DIY17.81.03.090 | 90x150 cm |
| DIY17.81.03.100 | 100x150 cm |
| DIY17.81.03.120 | 120x150 cm |



BARNA / BROWN

| | |
|-----------------|------------|
| DIY17.81.04.060 | 60x150 cm |
| DIY17.81.04.070 | 70x150 cm |
| DIY17.81.04.080 | 80x150 cm |
| DIY17.81.04.090 | 90x150 cm |
| DIY17.81.04.100 | 100x150 cm |
| DIY17.81.04.120 | 120x150 cm |



SZÜRKE / GRAY

| | |
|-----------------|------------|
| DIY17.81.12.060 | 60x150 cm |
| DIY17.81.12.070 | 70x150 cm |
| DIY17.81.12.080 | 80x150 cm |
| DIY17.81.12.090 | 90x150 cm |
| DIY17.81.12.100 | 100x150 cm |
| DIY17.81.12.120 | 120x150 cm |



FEHÉR / WHITE

| | |
|-------------------|------------|
| DIY17.82.01.060 | 60x150 cm |
| DIY17.82.01.070 | 70x150 cm |
| DIY17.82.01.080 | 80x150 cm |
| DIY17.82.01.090 | 90x150 cm |
| DIY17.82.01.100 | 100x150 cm |
| DIY17.82.01.120 | 120x150 cm |
| DIY17.82.01.80210 | 80x210 cm |
| DIY17.82.01.90210 | 90x210 cm |



BÉZS / BEIGE

| | |
|-------------------|------------|
| DIY17.82.03.060 | 60x150 cm |
| DIY17.82.03.070 | 70x150 cm |
| DIY17.82.03.080 | 80x150 cm |
| DIY17.82.03.090 | 90x150 cm |
| DIY17.82.03.100 | 100x150 cm |
| DIY17.82.03.120 | 120x150 cm |
| DIY17.82.03.80210 | 80x210 cm |
| DIY17.82.03.90210 | 90x210 cm |



BARNA / BROWN

| | |
|-------------------|------------|
| DIY17.82.04.060 | 60x150 cm |
| DIY17.82.04.070 | 70x150 cm |
| DIY17.82.04.080 | 80x150 cm |
| DIY17.82.04.090 | 90x150 cm |
| DIY17.82.04.100 | 100x150 cm |
| DIY17.82.04.120 | 120x150 cm |
| DIY17.82.04.80210 | 80x210 cm |
| DIY17.82.04.90210 | 90x210 cm |



MÁRVÁNY / MARBLE

| | |
|-------------------|------------|
| DIY17.82.30.060 | 60x150 cm |
| DIY17.82.30.070 | 70x150 cm |
| DIY17.82.30.080 | 80x150 cm |
| DIY17.82.30.090 | 90x150 cm |
| DIY17.82.30.100 | 100x150 cm |
| DIY17.82.30.120 | 120x150 cm |
| DIY17.82.30.80210 | 80x210 cm |
| DIY17.82.30.90210 | 90x210 cm |



GRÁNIT / GRANITE

| | |
|-------------------|------------|
| DIY17.82.31.060 | 60x150 cm |
| DIY17.82.31.070 | 70x150 cm |
| DIY17.82.31.080 | 80x150 cm |
| DIY17.82.31.090 | 90x150 cm |
| DIY17.82.31.100 | 100x150 cm |
| DIY17.82.31.120 | 120x150 cm |
| DIY17.82.31.80210 | 80x210 cm |
| DIY17.82.31.90210 | 90x210 cm |



GRAFIT / GRAPHITE

| | |
|-------------------|------------|
| DIY17.82.32.060 | 60x150 cm |
| DIY17.82.32.070 | 70x150 cm |
| DIY17.82.32.080 | 80x150 cm |
| DIY17.82.32.090 | 90x150 cm |
| DIY17.82.32.100 | 100x150 cm |
| DIY17.82.32.120 | 120x150 cm |
| DIY17.82.32.80210 | 80x210 cm |
| DIY17.82.32.90210 | 90x210 cm |



| FEHÉR / WHITE | |
|-------------------|------------|
| DIY17.90.01.045 | 45x160 cm |
| DIY17.90.01.060 | 60x160 cm |
| DIY17.90.01.070 | 70x160 cm |
| DIY17.90.01.080 | 80x160 cm |
| DIY17.90.01.090 | 90x160 cm |
| DIY17.90.01.100 | 100x160 cm |
| DIY17.90.01.120 | 120x160 cm |
| DIY17.90.01.60210 | 60x210 cm |
| DIY17.90.01.70210 | 70x210 cm |
| DIY17.90.01.80210 | 80x210 cm |
| DIY17.90.01.90210 | 90x210 cm |



| VANÍLIA / VANILLA | |
|-------------------|------------|
| DIY17.90.28.045 | 45x160 cm |
| DIY17.90.28.060 | 60x160 cm |
| DIY17.90.28.070 | 70x160 cm |
| DIY17.90.28.080 | 80x160 cm |
| DIY17.90.28.090 | 90x160 cm |
| DIY17.90.28.100 | 100x160 cm |
| DIY17.90.28.120 | 120x160 cm |
| DIY17.90.28.60210 | 60x210 cm |
| DIY17.90.28.70210 | 70x210 cm |
| DIY17.90.28.80210 | 80x210 cm |
| DIY17.90.28.90210 | 90x210 cm |

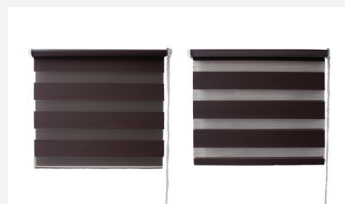

| BARNA / BROWN | |
|-------------------|------------|
| DIY17.90.04.045 | 45x160 cm |
| DIY17.90.04.060 | 60x160 cm |
| DIY17.90.04.070 | 70x160 cm |
| DIY17.90.04.080 | 80x160 cm |
| DIY17.90.04.090 | 90x160 cm |
| DIY17.90.04.100 | 100x160 cm |
| DIY17.90.04.120 | 120x160 cm |
| DIY17.90.04.60210 | 60x210 cm |
| DIY17.90.04.70210 | 70x210 cm |
| DIY17.90.04.80210 | 80x210 cm |
| DIY17.90.04.90210 | 90x210 cm |



| NARANCS / ORANGE | |
|-------------------|------------|
| DIY17.90.29.045 | 45x160 cm |
| DIY17.90.29.060 | 60x160 cm |
| DIY17.90.29.070 | 70x160 cm |
| DIY17.90.29.080 | 80x160 cm |
| DIY17.90.29.090 | 90x160 cm |
| DIY17.90.29.100 | 100x160 cm |
| DIY17.90.29.120 | 120x160 cm |
| DIY17.90.29.60210 | 60x210 cm |
| DIY17.90.29.70210 | 70x210 cm |
| DIY17.90.29.80210 | 80x210 cm |
| DIY17.90.29.90210 | 90x210 cm |

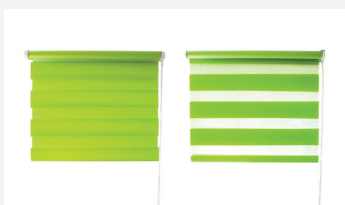

| ZÖLD / GREEN | |
|-------------------|------------|
| DIY17.90.07.045 | 45x160 cm |
| DIY17.90.07.060 | 60x160 cm |
| DIY17.90.07.070 | 70x160 cm |
| DIY17.90.07.080 | 80x160 cm |
| DIY17.90.07.090 | 90x160 cm |
| DIY17.90.07.100 | 100x160 cm |
| DIY17.90.07.120 | 120x160 cm |
| DIY17.90.07.60210 | 60x210 cm |
| DIY17.90.07.70210 | 70x210 cm |
| DIY17.90.07.80210 | 80x210 cm |
| DIY17.90.07.90210 | 90x210 cm |



| KARAMELL / CAMEL | |
|-------------------|------------|
| DIY17.90.25.045 | 45x160 cm |
| DIY17.90.25.060 | 60x160 cm |
| DIY17.90.25.070 | 70x160 cm |
| DIY17.90.25.080 | 80x160 cm |
| DIY17.90.25.090 | 90x160 cm |
| DIY17.90.25.100 | 100x160 cm |
| DIY17.90.25.120 | 120x160 cm |
| DIY17.90.25.60210 | 60x210 cm |
| DIY17.90.25.70210 | 70x210 cm |
| DIY17.90.25.80210 | 80x210 cm |
| DIY17.90.25.90210 | 90x210 cm |

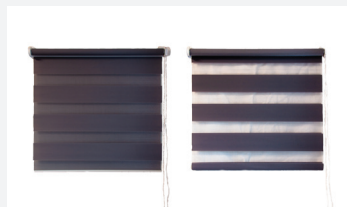

ANTRACIT / ANTHRACITE

| | |
|-------------------|------------|
| DIY17.90.76.045 | 45x160 cm |
| DIY17.90.76.060 | 60x160 cm |
| DIY17.90.76.070 | 70x160 cm |
| DIY17.90.76.080 | 80x160 cm |
| DIY17.90.76.090 | 90x160 cm |
| DIY17.90.76.100 | 100x160 cm |
| DIY17.90.76.120 | 120x160 cm |
| DIY17.90.76.60210 | 60x210 cm |
| DIY17.90.76.70210 | 70x210 cm |
| DIY17.90.76.80210 | 80x210 cm |
| DIY17.90.76.90210 | 90x210 cm |



HOMOK / SAND

| | |
|-------------------|------------|
| DIY17.90.41.045 | 45x160 cm |
| DIY17.90.41.060 | 60x160 cm |
| DIY17.90.41.070 | 70x160 cm |
| DIY17.90.41.080 | 80x160 cm |
| DIY17.90.41.090 | 90x160 cm |
| DIY17.90.41.100 | 100x160 cm |
| DIY17.90.41.120 | 120x160 cm |
| DIY17.90.41.60210 | 60x210 cm |
| DIY17.90.41.70210 | 70x210 cm |
| DIY17.90.41.80210 | 80x210 cm |
| DIY17.90.41.90210 | 90x210 cm |



PASZTEL / PASTEL

| | |
|-------------------|------------|
| DIY17.90.42.045 | 45x160 cm |
| DIY17.90.42.060 | 60x160 cm |
| DIY17.90.42.070 | 70x160 cm |
| DIY17.90.42.080 | 80x160 cm |
| DIY17.90.42.090 | 90x160 cm |
| DIY17.90.42.100 | 100x160 cm |
| DIY17.90.42.120 | 120x160 cm |
| DIY17.90.42.60210 | 60x210 cm |
| DIY17.90.42.70210 | 70x210 cm |
| DIY17.90.42.80210 | 80x210 cm |
| DIY17.90.42.90210 | 90x210 cm |

NEW



BOROSTYÁN / AMBER

| | |
|-------------------|------------|
| DIY17.90.43.045 | 45x160 cm |
| DIY17.90.43.060 | 60x160 cm |
| DIY17.90.43.070 | 70x160 cm |
| DIY17.90.43.080 | 80x160 cm |
| DIY17.90.43.090 | 90x160 cm |
| DIY17.90.43.100 | 100x160 cm |
| DIY17.90.43.120 | 120x160 cm |
| DIY17.90.43.60210 | 60x210 cm |
| DIY17.90.43.70210 | 70x210 cm |
| DIY17.90.43.80210 | 80x210 cm |
| DIY17.90.43.90210 | 90x210 cm |

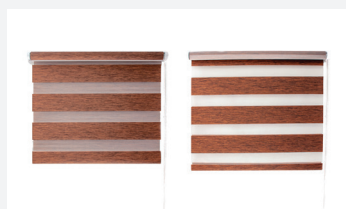

HOLDKŐ / MOONSTONE

| | |
|-------------------|------------|
| DIY17.90.44.045 | 45x160 cm |
| DIY17.90.44.060 | 60x160 cm |
| DIY17.90.44.070 | 70x160 cm |
| DIY17.90.44.080 | 80x160 cm |
| DIY17.90.44.090 | 90x160 cm |
| DIY17.90.44.100 | 100x160 cm |
| DIY17.90.44.120 | 120x160 cm |
| DIY17.90.44.60210 | 60x210 cm |
| DIY17.90.44.70210 | 70x210 cm |
| DIY17.90.44.80210 | 80x210 cm |
| DIY17.90.44.90210 | 90x210 cm |



KHEKI/KHEKI

| | |
|-------------------|------------|
| DIY17.90.46.045 | 45x160 cm |
| DIY17.90.46.060 | 60x160 cm |
| DIY17.90.46.070 | 70x160 cm |
| DIY17.90.46.080 | 80x160 cm |
| DIY17.90.46.090 | 90x160 cm |
| DIY17.90.46.100 | 100x160 cm |
| DIY17.90.46.120 | 120x160 cm |
| DIY17.90.46.60210 | 60x210 cm |
| DIY17.90.46.70210 | 70x210 cm |
| DIY17.90.46.80210 | 80x210 cm |
| DIY17.90.46.90210 | 90x210 cm |

NEW



**ÁTLÁTSZÓ SZILIKONOS SAROKVÉDŐ/
SILICONE CORNER PROTECTOR TRANSPARENT**

| | |
|------------------|------------|
| DIY119000.15-4 | 4 db/pcs |
| DIY119000.15-10 | 10 db/pcs |
| DIY119000.15-100 | 100 db/pcs |

Tartalomjegyzék

| | |
|--|----|
| Bemutatózás/ Introduction | 2 |
| Gyakori kérdések/ F.A.Q. | 3 |
| Kávéházi karnisok, Vitrage pálcák és tartozékaik/ Coffee house, Vitrage & accessories | 6 |
| Kihúzható fémkarnisok és tartozékaik/ Extendible metal curtain rods & accessories | 10 |
| Akciós karnisok/ Discount curtain rods | 13 |
| Ø16 mm -es fémkarnisok/ Ø16 mm metal set | 15 |
| Ø19 mm -es fémkarnisok/ Ø19 mm metal set | 25 |
| Ø25 mm -es fémkarnisok/ Ø25 mm metal set | 32 |
| Filigrano karnisok, pótsínek és tartozékaik/ Filigrano curtain rods, U-track & accessories | 38 |
| Mennyezeti sínek és tartozékaik/ Ceiling tracks & accessories | 43 |
| Alumínium mennyezeti profilok és tartozékaik/ Aluminium ceiling tracks & accessories | 53 |
| Kiegészítők/ Accessories | 59 |
| Statikus üvegfólia/ Static window foil | 63 |
| Rolók/ Rollo | 65 |
| Szilikonos sarokvédő/ Silicone corner protector | 70 |





Elérhetőség/Contact

Müller Rudolf - Emmert Adél

☎ +36 69 557 112

✉ info@hungaria-karnis.hu

🌐 www.hungaria-karnis.hu